

SPECTRUM **ILLUMINATION**

Machine Vision Lighting Since 1999

Spectrum Illumination

Print Ready Product Catalog Price List

Pricing effective January 2019



Ordering Information		2
Terms & Policies		3
Back Lights	(IP50)	4
Diffused Axial Lights	(IP50)	34
Multi-Channel Dome Lights	(IP50)	38
Dome Lights	(IP50)	45
Linear “Bright Field” Lights	(IP50)	56
Oxy (Flat Dome) Lights	(IP50)	98
Ring “Bright Field” Lights	(IP50)	102
Spot Lights	(IP50)	122
TriPod Lights	(IP50)	136
Washdown Lights	(IP68)	140
Controllers/Drivers and Cables	(IP50)	156
Warranty		167
Index		170

Ordering Information

Order specification examples are shown throughout the price book at the top of each page. Be sure to follow the order sequence carefully to ensure complete and accurate order specification.

After placing an order, Spectrum Illumination will send an order acknowledgement.

Send orders to:

customerservice@si-lights.com or fax to 231-894-4582

Please review information such as ship date, ship address, and items ordered for accuracy.

Placing an Order

For accurate order processing on faxed orders, please type your order or use legible handwriting, and be sure to include the following information:

1. A complete "sold to" address with correct Zip code.
2. A complete "ship to" address with correct Zip code.
3. A purchase order number. (The order is issued to Spectrum Illumination, Montague, Michigan.)
4. A signature or name of person authorizing the purchase order.
5. A contact name, phone number and email address at your company.
6. An actual calendar date for the requested delivery date (not ASAP).
7. Line items that are complete, which means all catalog numbers and descriptions, options listed for each product selected. Be sure to make a pick for all available options. Also, combine identical items and specify total quantity unless using special marking or tagging. (Refer to the price book for ordering options.)

8. Special products referenced by their control numbers as well as their descriptions.

9. Line items that include price per unit, as well as extended totals.

10. A total dollar amount for the purchase order.

11. Any special shipping requirements clearly noted; i.e., "call before delivery."

By placing your orders correctly and completely the first time around, your order will be processed and scheduled without delay (subject to credit approval).

Lead-Times

Spectrum Illumination has a standard lead time of two (2) weeks. However, some items may take longer as they may be a specialty and therefore made to order.

Note: Shipping lead-times are subject to product availability due to order size. For exact lead-times on your order contact Spectrum Illumination Customer Service.

Product Questions, Quotes & Order Placement.

Hours: Monday-Friday 9am to 5pm EST

Customer Service Representative
Hours: Monday-Friday 9am to 5pm EST
Phone: 1-231-894-4590
Fax: 1-231-894-4582
e-mail: customerservice@si-lights.com

For more information on Order Placement, Confirmation and Lead-Times, see the Terms & Policies section in this book.

1. Prices

Spectrum Illumination reserves the right to change prices without notice. Firm quotations are available upon request and will be honored for a period of fifteen(15) days.

2. Confirmation

Upon receiving an order, Spectrum Illumination will send an order acknowledgment with exact pricing information and scheduled shipping date. Customer is responsible for checking acknowledgments to ensure that the order is correct. Order will be processed as acknowledged.

3. Lead Times

Spectrum Illumination reserves the right to alter lead times as demand for products fluctuate. Stated lead times begin after an order is entered and scheduled. Shipments are subject to product availability. Special products and larger orders may extend leadtimes. Please contact customer service for exact lead times.

Spectrum Illumination has a standard lead time of two (2) weeks. However, some items may take longer as they may be a specialty and therefore made to order.

4. Past Due Accounts

Past Due Accounts will be charged 1.5% per month. This is an annual rate of 18% or the highest legal rate on the unpaid balance. The purchaser agrees to pay all collection agency fees, court costs, and/or reasonable attorney fees incurred by Spectrum Illumination in the collection of past due balances.

Auto Burst

Our patented LED controller bursts the LED's at high current for 500µs, then drops to a normal constant current that is safe for LED's. This eliminates the need to choose between strobe only or constant style light. Burst pulse is fully adjustable via trim potentiometer or 0-10VDC input. For users not wanting the burst feature, it can be disabled by DIP switch.

HS Strobe

All of our lights have a high-speed strobe input. Standard series lights have <math><1\mu\text{s}</math> and Monster series have 3µs typical turn on response times.

Durable construction

All lights are manufactured with high quality materials. Durable construction reduce machine downtime.

Robot Friendly

Lights with this icon are manufactured using light weight materials and/or materials that will minimize machine damage if robot crash occurs, reducing machine downtime.

RoHS

All lights meet or exceed Restriction of Hazardous Substances directive. We care about our environment, employees, customers and future.

No Driver Required

Lights with this designation run directly on 24 VDC and include strobe control.

Internal Driver

Lights with this designation have on-board integrated driver/controller. Lights are 24 VDC.

External Driver

Lights with this designation come with the required external DIN Rail driver/controller. The external driver/controller allows control of High Speed Strobe and continuous operation. Lights are 24 VDC.



No Driver Required

Internal Driver

External Driver

Auto Burst 2.4x TriPod

Auto Burst 3.5x EL & XL Series



HS Strobe Monster & Standard Series

Durable Construction

Robot Friendly

Restriction of Hazardous Substances

Back Lights

 Standard-Series Back Lights - No Driver Required	5-18
 Monster-Series Back Lights - External Driver Included	19-33



MACHINE VISION LIGHTING SINCE 1999

Standard-Series Back Lights



Spectrum Illumination's Standard-Series Back Lights are designed to create high contrast silhouettes for Machine Vision Applications. They can also be used to create front lighting in cases where minimal lighting is needed. Our lights are built using Modular Board Technology (MBT). Because we use MBT we can make any size back light in 1" (25.4mm) by 2" (50.8mm) incremental dimensions.



Units come with light and cable.

Series Highlights

- No driver/controller required
- HS (High Speed) Strobe Technology
- 24 VDC
- M12 connector for quick disconnect
- Available in 4 colors and Infrared
- Available in 25+ sizes plus custom sizes
- 10 Year Warranty* - 100,000 hours

Units come with light and cable.

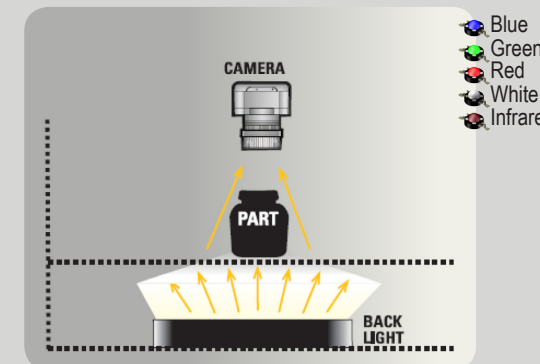

*10-Year warranty on registered products
 *6-Year warranty on non-registered products
 *3-year warranty on washdown lights
 spectrumillumination/limited-warranty/

Application Examples

- Automotive and aerospace processing
- Custom conveyor
- Defects on surfaces
- Inspection
- Locate mounting holes
- Pharmaceutical
- View openings (e.g. drilled holes)

P: (231) 894-4590
 E: sales@si-lights.com

si-lights.com

Standard-Series Back Lights

Features:

- M12 connector for quick disconnect
- High speed built-in strobe
- 24VDC
- No driver/controller required
- Available in 4 colors and Infrared (IR)
- Available in 25+ sizes plus custom
- 10 Year Warranty* - 100,000 hours

Backlights run directly on 24 VDC and have strobe control. Backlights come with a standard 4 pin m12 connector. Spectrum Illumination Standard Series Lights are engineered to provide up to 100,000 hours of trouble free operation.

To Order, Specify;

1 Base Part Number	BL14
Example:	\$525
2 Specify LED Color	470
	+ \$50
3 Specify Diffuser Type	WD
	+ \$0
4 Specify Cable Option	SC4
	+ \$0

1 Base Part Number	List Price	2 LED Color	3 Diffuser Type	4 Cable Option
BL14 1" X 4" Back Light LED - Package Includes Light, and 4 Meter Cable	\$525	470 + \$50 Blue	WD + \$0 White Diffuser	SC4 + \$0 Standard Cable 4 meter
		530 + \$50 Green	CC + \$25 Clear Cover	SC8 + \$50 Standard Cable 8 meter
		660 + \$0 Red	SD + \$25 Standard Diffuser	SC15 + \$70 Standard Cable 15 meter
		880 + \$0 Infrared	TFD + \$25 Thin Film Diffuser	SC30 + \$110 Standard Cable 30 meter
		WHI + \$50 White	P + \$25 Polarizer	SCHF4 + \$75 Standard High Flex Cable 4 meter
				SCHF8 + \$100 Standard High Flex Cable 8 meter
				SCHF15 + \$150 Standard High Flex Cable 15 meter



Standard Dimensions

W	2"
L	5"
H	.85"

BL18 1" X 8" Back Light LED - Package Includes Light, and 4 Meter Cable	\$575	470 + \$50 Blue	WD + \$0 White Diffuser	SC4 + \$0 Standard Cable 4 meter
		530 + \$50 Green	CC + \$25 Clear Cover	SC8 + \$50 Standard Cable 8 meter
		660 + \$0 Red	SD + \$25 Standard Diffuser	SC15 + \$70 Standard Cable 15 meter
		880 + \$0 Infrared	TFD + \$25 Thin Film Diffuser	SC30 + \$110 Standard Cable 30 meter
		WHI + \$50 White	P + \$25 Polarizer	SCHF4 + \$75 Standard High Flex Cable 4 meter
				SCHF8 + \$100 Standard High Flex Cable 8 meter
				SCHF15 + \$150 Standard High Flex Cable 15 meter



Standard Dimensions

W	2"
L	9"
H	.85"
Wgt	.75 lbs

Standard-Series Back Lights

Features:

- M12 connector for quick disconnect
- High speed built-in strobe
- 24VDC
- No driver/controller required
- Available in 4 colors and Infrared (IR)
- Available in 25+ sizes plus custom
- 10 Year Warranty* - 100,000 hours

Backlights run directly on 24 VDC and have strobe control. Backlights come with a standard 4 pin m12 connector. Spectrum Illumination Standard Series Lights are engineered to provide up to 100,000 hours of trouble free operation.

To Order, Specify;

1 Base Part Number	BL22
Example:	\$525
2 Specify LED Color	470
	+ \$25
3 Specify Diffuser Type	WD
	+ \$0
4 Specify Cable Option	SC4
	+ \$0

1 Base Part Number	List Price	2 LED Color	3 Diffuser Type	4 Cable Option
BL22 2" X 2" Back Light LED - Package Includes Light, and 4 Meter Cable	\$525	470 + \$25 Blue	WD + \$0 White Diffuser	SC4 + \$0 Standard Cable 4 meter
		530 + \$50 Green	CC + \$25 Clear Cover	SC8 + \$50 Standard Cable 8 meter
		660 + \$0 Red	SD + \$25 Standard Diffuser	SC15 + \$70 Standard Cable 15 meter
		880 + \$0 Infrared	TFD + \$25 Thin Film Diffuser	SC30 + \$110 Standard Cable 30 meter
		WHI + \$25 White	P + \$25 Polarizer	SCHF4 + \$75 Standard High Flex Cable 4 meter
				SCHF8 + \$100 Standard High Flex Cable 8 meter
				SCHF15 + \$150 Standard High Flex Cable 15 meter



Standard Dimensions

W	3"
L	3"
H	.85"
Wgt	.40 lbs

BL24 2" X 4" Back Light LED - Package Includes Light, and 4 Meter Cable	\$575	470 + \$50 Blue	WD + \$0 White Diffuser	SC4 + \$0 Standard Cable 4 meter
		530 + \$50 Green	CC + \$25 Clear Cover	SC8 + \$50 Standard Cable 8 meter
		660 + \$0 Red	SD + \$25 Standard Diffuser	SC15 + \$70 Standard Cable 15 meter
		880 + \$0 Infrared	TFD + \$25 Thin Film Diffuser	SC30 + \$110 Standard Cable 30 meter
		WHI + \$50 White	P + \$25 Polarizer	SCHF4 + \$75 Standard High Flex Cable 4 meter
				SCHF8 + \$100 Standard High Flex Cable 8 meter
				SCHF15 + \$150 Standard High Flex Cable 15 meter



Standard Dimensions

W	3"
L	5"
H	.85"
Wgt	.55 lbs

Standard-Series Back Lights

Features:

- M12 connector for quick disconnect
- High speed built-in strobe
- 24VDC
- No driver/controller required
- Available in 4 colors and Infrared (IR)
- Available in 25+ sizes plus custom
- 10 Year Warranty* - 100,000 hours

Backlights run directly on 24 VDC and have strobe control. Backlights come with a standard 4 pin m12 connector. Spectrum Illumination Standard Series Lights are engineered to provide up to 100,000 hours of trouble free operation.

To Order, Specify;	
1 Base Part Number	BL26
Example:	\$650
2 Specify LED Color	470
	+ \$75
3 Specify Diffuser Type	WD
	+ \$0
4 Specify Cable Option	SC4
	+ \$0

1 Base Part Number	List Price	2 LED Color	3 Diffuser Type	4 Cable Option
BL26 2" X 6" Back Light LED - Package Includes Light, and 4 Meter Cable	\$650	470 + \$75 Blue	WD + \$0 White Diffuser	SC4 + \$0 Standard Cable 4 meter
		530 + \$75 Green	CC + \$25 Clear Cover	SC8 + \$50 Standard Cable 8 meter
Standard Dimensions		660 + \$0 Red	SD + \$25 Standard Diffuser	SC15 + \$70 Standard Cable 15 meter
W 3"		880 + \$0 Infrared	TFD + \$25 Thin Film Diffuser	SC30 + \$110 Standard Cable 30 meter
L 7"		WHI + \$75 White	P + \$25 Polarizer	SCHF4 + \$75 Standard High Flex Cable 4 meter
H .85"				SCHF8 + \$100 Standard High Flex Cable 8 meter
Wgt .73 lbs				SCHF15 + \$150 Standard High Flex Cable 15 meter

BL210 2" X 10" Back Light LED - Package Includes Light, and 4 Meter Cable	\$925	470 + \$100 Blue	WD + \$0 White Diffuser	SC4 + \$0 Standard Cable 4 meter
		530 + \$100 Green	CC + \$25 Clear Cover	SC8 + \$50 Standard Cable 8 meter
Standard Dimensions		660 + \$0 Red	SD + \$25 Standard Diffuser	SC15 + \$70 Standard Cable 15 meter
W 3"		880 + \$0 Infrared	TFD + \$25 Thin Film Diffuser	SC30 + \$110 Standard Cable 30 meter
L 11"		WHI + \$100 White	P + \$25 Polarizer	SCHF4 + \$75 Standard High Flex Cable 4 meter
H .85"				SCHF8 + \$100 Standard High Flex Cable 8 meter
				SCHF15 + \$150 Standard High Flex Cable 15 meter

Standard-Series Back Lights

Features:

- M12 connector for quick disconnect
- High speed built-in strobe
- 24VDC
- No driver/controller required
- Available in 4 colors and Infrared (IR)
- Available in 25+ sizes plus custom
- 10 Year Warranty* - 100,000 hours

Backlights run directly on 24 VDC and have strobe control. Backlights come with a standard 4 pin m12 connector. Spectrum Illumination Standard Series Lights are engineered to provide up to 100,000 hours of trouble free operation.

To Order, Specify;	
1 Base Part Number	BL34
Example:	\$650
2 Specify LED Color	470
	+ \$75
3 Specify Diffuser Type	WD
	+ \$0
4 Specify Cable Option	SC4
	+ \$0

1 Base Part Number	List Price	2 LED Color	3 Diffuser Type	4 Cable Option
BL34 3" X 4" Back Light LED - Package Includes Light, and 4 Meter Cable	\$650	470 + \$75 Blue	WD + \$0 White Diffuser	SC4 + \$0 Standard Cable 4 meter
		530 + \$75 Green	CC + \$25 Clear Cover	SC8 + \$50 Standard Cable 8 meter
Standard Dimensions		660 + \$0 Red	SD + \$25 Standard Diffuser	SC15 + \$70 Standard Cable 15 meter
W 4"		880 + \$0 Infrared	TFD + \$25 Thin Film Diffuser	SC30 + \$110 Standard Cable 30 meter
L 5"		WHI + \$75 White	P + \$25 Polarizer	SCHF4 + \$75 Standard High Flex Cable 4 meter
H .85"				SCHF8 + \$100 Standard High Flex Cable 8 meter
Wgt .68 lbs				SCHF15 + \$150 Standard High Flex Cable 15 meter

BL36 3" X 6" Back Light LED - Package Includes Light, and 4 Meter Cable	\$775	470 + \$100 Blue	WD + \$0 White Diffuser	SC4 + \$0 Standard Cable 4 meter
		530 + \$100 Green	CC + \$25 Clear Cover	SC8 + \$50 Standard Cable 8 meter
Standard Dimensions		660 + \$0 Red	SD + \$25 Standard Diffuser	SC15 + \$70 Standard Cable 15 meter
W 4"		880 + \$0 Infrared	TFD + \$25 Thin Film Diffuser	SC30 + \$110 Standard Cable 30 meter
L 7"		WHI + \$100 White	P + \$25 Polarizer	SCHF4 + \$75 Standard High Flex Cable 4 meter
H .85"				SCHF8 + \$100 Standard High Flex Cable 8 meter
				SCHF15 + \$150 Standard High Flex Cable 15 meter

Standard-Series Back Lights

Features:

- M12 connector for quick disconnect
- High speed built-in strobe
- 24VDC
- No driver/controller required
- Available in 4 colors and Infrared (IR)
- Available in 25+ sizes plus custom
- 10 Year Warranty* - 100,000 hours

Backlights run directly on 24 VDC and have strobe control. Backlights come with a standard 4 pin m12 connector. Spectrum Illumination Standard Series Lights are engineered to provide up to 100,000 hours of trouble free operation.

To Order, Specify;

① Base Part Number	BL38
Example:	\$825
② Specify LED Color	660
	+ \$0
③ Specify Diffuser Type	WD
	+ \$0
④ Specify Cable Option	SC4
	+ \$0

① Base Part Number	List Price	② LED Color	③ Diffuser Type	④ Cable Option
BL38 3" X 8" Back Light LED - Package Includes Light, and 4 Meter Cable	\$825	470 * Blue	WD + \$0 White Diffuser	SC4 + \$0 Standard Cable 4 meter
		530 * Green	CC + \$25 Clear Cover	SC8 + \$50 Standard Cable 8 meter
		660 + \$0 Red	SD + \$25 Standard Diffuser	SC15 + \$70 Standard Cable 15 meter
		880 + \$0 Infrared	TFD + \$25 Thin Film Diffuser	SC30 + \$110 Standard Cable 30 meter
		WHI * White	P + \$25 Polarizer	SCHF4 + \$75 Standard High Flex Cable 4 meter
Standard Dimensions		*Call for pricing		
W 4"				SCHF8 + \$100 Standard High Flex Cable 8 meter
L 9"				SCHF15 + \$150 Standard High Flex Cable 15 meter
H .85"				
Wgt 1.05 lbs				

BL312 3" X 12" Back Light LED - Package Includes Light, and 4 Meter Cable	\$1400	470 + \$300 Blue	WD + \$0 White Diffuser	SC4 + \$0 Standard Cable 4 meter
		530 + \$300 Green	CC + \$25 Clear Cover	SC8 + \$50 Standard Cable 8 meter
		660 + \$0 Red	SD + \$25 Standard Diffuser	SC15 + \$70 Standard Cable 15 meter
		880 + \$0 Infrared	TFD + \$25 Thin Film Diffuser	SC30 + \$110 Standard Cable 30 meter
		WHI + \$300 White	P + \$25 Polarizer	SCHF4 + \$75 Standard High Flex Cable 4 meter
Standard Dimensions				SCHF8 + \$100 Standard High Flex Cable 8 meter
W 4"				SCHF15 + \$150 Standard High Flex Cable 15 meter
L 13"				
H .85"				
Wgt 1.58 lbs				

Standard-Series Back Lights

Features:

- M12 connector for quick disconnect
- High speed built-in strobe
- 24VDC
- No driver/controller required
- Available in 4 colors and Infrared (IR)
- Available in 25+ sizes plus custom
- 10 Year Warranty* - 100,000 hours

Backlights run directly on 24 VDC and have strobe control. Backlights come with a standard 4 pin m12 connector. Spectrum Illumination Standard Series Lights are engineered to provide up to 100,000 hours of trouble free operation.

To Order, Specify;

① Base Part Number	BL44
Example:	\$675
② Specify LED Color	470
	+ \$75
③ Specify Diffuser Type	WD
	+ \$0
④ Specify Cable Option	SC4
	+ \$0

① Base Part Number	List Price	② LED Color	③ Diffuser Type	④ Cable Option
BL44 4" X 4" Back Light LED - Package Includes Light, and 4 Meter Cable	\$675	470 + \$75 Blue	WD + \$0 White Diffuser	SC4 + \$0 Standard Cable 4 meter
		530 + \$75 Green	CC + \$25 Clear Cover	SC8 + \$50 Standard Cable 8 meter
		660 + \$0 Red	SD + \$25 Standard Diffuser	SC15 + \$70 Standard Cable 15 meter
		880 + \$0 Infrared	TFD + \$25 Thin Film Diffuser	SC30 + \$110 Standard Cable 30 meter
		WHI + \$75 White	P + \$25 Polarizer	SCHF4 + \$75 Standard High Flex Cable 4 meter
Standard Dimensions				SCHF8 + \$100 Standard High Flex Cable 8 meter
W 5"				SCHF15 + \$150 Standard High Flex Cable 15 meter
L 5"				
H .85"				
Wgt .8 lbs				

BL46 4" X 6" Back Light LED - Package Includes Light, and 4 Meter Cable	\$825	470 + \$150 Blue	WD + \$0 White Diffuser	SC4 + \$0 Standard Cable 4 meter
		530 + \$150 Green	CC + \$25 Clear Cover	SC8 + \$50 Standard Cable 8 meter
		660 + \$0 Red	SD + \$25 Standard Diffuser	SC15 + \$70 Standard Cable 15 meter
		880 + \$0 Infrared	TFD + \$25 Thin Film Diffuser	SC30 + \$110 Standard Cable 30 meter
		WHI + \$150 White	P + \$25 Polarizer	SCHF4 + \$75 Standard High Flex Cable 4 meter
Standard Dimensions				SCHF8 + \$100 Standard High Flex Cable 8 meter
W 5"				SCHF15 + \$150 Standard High Flex Cable 15 meter
L 7"				
H .85"				
Wgt 1.05 lbs				

Standard-Series Back Lights

Features:

- M12 connector for quick disconnect
- High speed built-in strobe
- 24VDC
- No driver/controller required
- Available in 4 colors and Infrared (IR)
- Available in 25+ sizes plus custom
- 10 Year Warranty* - 100,000 hours

Backlights run directly on 24 VDC and have strobe control. Backlights come with a standard 4 pin m12 connector. Spectrum Illumination Standard Series Lights are engineered to provide up to 100,000 hours of trouble free operation.

To Order, Specify;	
① Base Part Number	BL48
Example:	\$875
② Specify LED Color	660
	+ \$0
③ Specify Diffuser Type	WD
	+ \$0
④ Specify Cable Option	SC4
	+ \$0

① Base Part Number	List Price	② LED Color	③ Diffuser Type	④ Cable Option
BL48 4" X 8" Back Light LED - Package Includes Light, and 4 Meter Cable	\$875	470 + \$355 Blue	WD + \$0 White Diffuser	SC4 + \$0 Standard Cable 4 meter
		530 + \$355 Green	CC + \$25 Clear Cover	SC8 + \$50 Standard Cable 8 meter
Standard Dimensions		660 + \$0 Red	SD + \$25 Standard Diffuser	SC15 + \$70 Standard Cable 15 meter
W 5"		880 + \$0 Infrared	TFD + \$25 Thin Film Diffuser	SC30 + \$110 Standard Cable 30 meter
L 9"		WHI + \$355 White	P + \$25 Polarizer	SCHF4 + \$75 Standard High Flex Cable 4 meter
H .85"				SCHF8 + \$100 Standard High Flex Cable 8 meter
Wgt 1.36 lbs				SCHF15 + \$150 Standard High Flex Cable 15 meter

BL414 4" X 14" Back Light LED - Package Includes Light, and 4 Meter Cable	\$1700	470 + \$450 Blue	WD + \$0 White Diffuser	SC4 + \$0 Standard Cable 4 meter
		530 + \$450 Green	CC + \$25 Clear Cover	SC8 + \$50 Standard Cable 8 meter
Standard Dimensions		660 + \$0 Red	SD + \$25 Standard Diffuser	SC15 + \$70 Standard Cable 15 meter
W 5"		880 + \$0 Infrared	TFD + \$25 Thin Film Diffuser	SC30 + \$110 Standard Cable 30 meter
L 15"		WHI + \$450 White	P + \$25 Polarizer	SCHF4 + \$75 Standard High Flex Cable 4 meter
H .85"				SCHF8 + \$100 Standard High Flex Cable 8 meter
				SCHF15 + \$150 Standard High Flex Cable 15 meter

Standard-Series Back Lights

Features:

- M12 connector for quick disconnect
- High speed built-in strobe
- 24VDC
- No driver/controller required
- Available in 4 colors and Infrared (IR)
- Available in 25+ sizes plus custom
- 10 Year Warranty* - 100,000 hours

Backlights run directly on 24 VDC and have strobe control. Backlights come with a standard 4 pin m12 connector. Spectrum Illumination Standard Series Lights are engineered to provide up to 100,000 hours of trouble free operation.

To Order, Specify;	
① Base Part Number	BL56
Example:	\$900
② Specify LED Color	660
	+ \$0
③ Specify Diffuser Type	WD
	+ \$0
④ Specify Cable Option	SC4
	+ \$0

① Base Part Number	List Price	② LED Color	③ Diffuser Type	④ Cable Option
BL56 5" X 6" Back Light LED - Package Includes Light, and 4 Meter Cable	\$900	470 + \$325 Blue	WD + \$0 White Diffuser	SC4 + \$0 Standard Cable 4 meter
		530 + \$325 Green	CC + \$25 Clear Cover	SC8 + \$50 Standard Cable 8 meter
Standard Dimensions		660 + \$0 Red	SD + \$25 Standard Diffuser	SC15 + \$70 Standard Cable 15 meter
W 6"		880 + \$0 Infrared	TFD + \$25 Thin Film Diffuser	SC30 + \$110 Standard Cable 30 meter
L 7"		WHI + \$325 White	P + \$25 Polarizer	SCHF4 + \$75 Standard High Flex Cable 4 meter
H .85"				SCHF8 + \$100 Standard High Flex Cable 8 meter
Wgt 1.30 lbs				SCHF15 + \$150 Standard High Flex Cable 15 meter

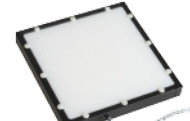
BL66 6" X 6" Back Light LED - Package Includes Light, and 4 Meter Cable	\$1050	470 + \$350 Blue	WD + \$0 White Diffuser	SC4 + \$0 Standard Cable 4 meter
		530 + \$350 Green	CC + \$25 Clear Cover	SC8 + \$50 Standard Cable 8 meter
Standard Dimensions		660 + \$0 Red	SD + \$25 Standard Diffuser	SC15 + \$70 Standard Cable 15 meter
W 7"		880 + \$0 Infrared	TFD + \$25 Thin Film Diffuser	SC30 + \$110 Standard Cable 30 meter
L 7"		WHI + \$350 White	P + \$25 Polarizer	SCHF4 + \$75 Standard High Flex Cable 4 meter
H .85"				SCHF8 + \$100 Standard High Flex Cable 8 meter
				SCHF15 + \$150 Standard High Flex Cable 15 meter

Standard-Series Back Lights

Features:

- M12 connector for quick disconnect
- High speed built-in strobe
- 24VDC
- No driver/controller required
- Available in 4 colors and Infrared (IR)
- Available in 25+ sizes plus custom
- 10 Year Warranty* - 100,000 hours

Backlights run directly on 24 VDC and have strobe control. Backlights come with a standard 4 pin m12 connector. Spectrum Illumination Standard Series Lights are engineered to provide up to 100,000 hours of trouble free operation.

To Order, Specify;	
1 Base Part Number	BL68
Example:	\$1475
2 Specify LED Color	660
	+ \$0
3 Specify Diffuser Type	WD
	+ \$0
4 Specify Cable Option	SC4
	+ \$0

1 Base Part Number	List Price	2 LED Color	3 Diffuser Type	4 Cable Option
BL68 6" X 8" Back Light LED - Package Includes Light, and 4 Meter Cable	\$1475	470 + \$375 Blue	WD + \$0 White Diffuser	SC4 + \$0 Standard Cable 4 meter
		530 + \$375 Green	CC + \$25 Clear Cover	SC8 + \$50 Standard Cable 8 meter
		660 + \$0 Red	SD + \$25 Standard Diffuser	SC15 + \$70 Standard Cable 15 meter
		880 + \$0 Infrared	TFD + \$25 Thin Film Diffuser	SC30 + \$110 Standard Cable 30 meter
		WHI + \$375 White	P + \$25 Polarizer	SCHF4 + \$75 Standard High Flex Cable 4 meter
				SCHF8 + \$100 Standard High Flex Cable 8 meter
				SCHF15 + \$150 Standard High Flex Cable 15 meter

Standard Dimensions

W 7"

L 9"

H .85"

Wgt 1.75 lbs

BL610 6" X 10" Back Light LED - Package Includes Light, and 4 Meter Cable	\$1750	470 * Blue	WD + \$0 White Diffuser	SC4 + \$0 Standard Cable 4 meter
		530 * Green	CC + \$25 Clear Cover	SC8 + \$50 Standard Cable 8 meter
		660 + \$0 Red	SD + \$25 Standard Diffuser	SC15 + \$70 Standard Cable 15 meter
		880 + \$0 Infrared	TFD + \$25 Thin Film Diffuser	SC30 + \$110 Standard Cable 30 meter
		WHI * White	P + \$25 Polarizer	SCHF4 + \$75 Standard High Flex Cable 4 meter
				SCHF8 + \$100 Standard High Flex Cable 8 meter
				SCHF15 + \$150 Standard High Flex Cable 15 meter

Standard Dimensions

W 7"

L 11"

H .85"

*Call for pricing

Standard-Series Back Lights

Features:

- M12 connector for quick disconnect
- High speed built-in strobe
- 24VDC
- No driver/controller required
- Available in 4 colors and Infrared (IR)
- Available in 25+ sizes plus custom
- 10 Year Warranty* - 100,000 hours

Backlights run directly on 24 VDC and have strobe control. Backlights come with a standard 4 pin m12 connector. Spectrum Illumination Standard Series Lights are engineered to provide up to 100,000 hours of trouble free operation.

To Order, Specify;	
1 Base Part Number	BL612
Example:	\$1900
2 Specify LED Color	660
	+ \$0
3 Specify Diffuser Type	WD
	+ \$0
4 Specify Cable Option	SC4
	+ \$0

1 Base Part Number	List Price	2 LED Color	3 Diffuser Type	4 Cable Option
BL612 6" X 12" Back Light LED - Package Includes Light, and 4 Meter Cable	\$1900	470 + \$400 Blue	WD + \$0 White Diffuser	SC4 + \$0 Standard Cable 4 meter
		530 + \$400 Green	CC + \$25 Clear Cover	SC8 + \$50 Standard Cable 8 meter
		660 + \$0 Red	SD + \$25 Standard Diffuser	SC15 + \$70 Standard Cable 15 meter
		880 + \$0 Infrared	TFD + \$25 Thin Film Diffuser	SC30 + \$110 Standard Cable 30 meter
		WHI + \$400 White	P + \$25 Polarizer	SCHF4 + \$75 Standard High Flex Cable 4 meter
				SCHF8 + \$100 Standard High Flex Cable 8 meter
				SCHF15 + \$150 Standard High Flex Cable 15 meter

Standard Dimensions

W 7"

L 13"

H .85"

BL618 6" X 18" Back Light LED - Package Includes Light, and 4 Meter Cable	\$3750	470 * Blue	WD + \$0 White Diffuser	SC4 + \$0 Standard Cable 4 meter
		530 * Green	CC + \$25 Clear Cover	SC8 + \$50 Standard Cable 8 meter
		660 + \$0 Red	SD + \$25 Standard Diffuser	SC15 + \$70 Standard Cable 15 meter
		880 + \$0 Infrared	TFD + \$25 Thin Film Diffuser	SC30 + \$110 Standard Cable 30 meter
		WHI * White	P + \$25 Polarizer	SCHF4 + \$75 Standard High Flex Cable 4 meter
				SCHF8 + \$100 Standard High Flex Cable 8 meter
				SCHF15 + \$150 Standard High Flex Cable 15 meter

Standard Dimensions

W 7"

L 19"

H .85"

*Call for pricing

Back Lights
 Diffused Axial
 Dome Lights
 Linear Lights
 Oxy Lights
 Ring Lights
 Spot Lights
 TriPod Lights
 Washdown Lights
 Controllers & Cables

Back Lights
 Diffused Axial
 Dome Lights
 Linear Lights
 Oxy Lights
 Ring Lights
 Spot Lights
 TriPod Lights
 Washdown Lights
 Controllers & Cables

Standard-Series Back Lights

Features:

- M12 connector for quick disconnect
- High speed built-in strobe
- 24VDC
- No driver/controller required
- Available in 4 colors and Infrared (IR)
- Available in 25+ sizes plus custom
- 10 Year Warranty* - 100,000 hours

Backlights run directly on 24 VDC and have strobe control. Backlights come with a standard 4 pin m12 connector. Spectrum Illumination Standard Series Lights are engineered to provide up to 100,000 hours of trouble free operation.

To Order, Specify;	
① Base Part Number	BL88
Example:	\$2000
② Specify LED Color	660
	+ \$0
③ Specify Diffuser Type	WD
	+ \$0
④ Specify Cable Option	SC4
	+ \$0

① Base Part Number	List Price	② LED Color	③ Diffuser Type	④ Cable Option
BL88 8" X 8" Back Light LED - Package Includes Light, and 4 Meter Cable	\$2000	470 + \$400 Blue	WD + \$0 White Diffuser	SC4 + \$0 Standard Cable 4 meter
		530 + \$400 Green	CC + \$25 Clear Cover	SC8 + \$50 Standard Cable 8 meter
		660 + \$0 Red	SD + \$25 Standard Diffuser	SC15 + \$70 Standard Cable 15 meter
		880 + \$0 Infrared	TFD + \$25 Thin Film Diffuser	SC30 + \$110 Standard Cable 30 meter
		WHI + \$400 White	P + \$25 Polarizer	SCHF4 + \$75 Standard High Flex Cable 4 meter
				SCHF8 + \$100 Standard High Flex Cable 8 meter
				SCHF15 + \$150 Standard High Flex Cable 15 meter

Standard Dimensions

W 9"

L 9"

H .85"

BL812 8" X 12" Back Light LED - Package Includes Light, and 4 Meter Cable	\$2150	470 + \$500 Blue	WD + \$0 White Diffuser	SC4 + \$0 Standard Cable 4 meter
		530 + \$500 Green	CC + \$25 Clear Cover	SC8 + \$50 Standard Cable 8 meter
		660 + \$0 Red	SD + \$25 Standard Diffuser	SC15 + \$70 Standard Cable 15 meter
		880 + \$0 Infrared	TFD + \$25 Thin Film Diffuser	SC30 + \$110 Standard Cable 30 meter
		WHI + \$500 White	P + \$50 Polarizer	SCHF4 + \$75 Standard High Flex Cable 4 meter
				SCHF8 + \$100 Standard High Flex Cable 8 meter
				SCHF15 + \$150 Standard High Flex Cable 15 meter

Standard Dimensions

W 9"

L 13"

H .85"

Wgt 3.05 lbs

Standard-Series Back Lights

Features:

- M12 connector for quick disconnect
- High speed built-in strobe
- 24VDC
- No driver/controller required
- Available in 4 colors and Infrared (IR)
- Available in 25+ sizes plus custom
- 10 Year Warranty* - 100,000 hours

Backlights run directly on 24 VDC and have strobe control. Backlights come with a standard 4 pin m12 connector. Spectrum Illumination Standard Series Lights are engineered to provide up to 100,000 hours of trouble free operation.

To Order, Specify;	
① Base Part Number	BL824
Example:	\$5850
② Specify LED Color	660
	+ \$0
③ Specify Diffuser Type	WD
	+ \$0
④ Specify Cable Option	SC4
	+ \$0

① Base Part Number	List Price	② LED Color	③ Diffuser Type	④ Cable Option
BL824 8" X 24" Back Light LED - Package Includes Light, and 4 Meter Cable	\$5850	470 * Blue	WD + \$0 White Diffuser	SC4 + \$0 Standard Cable 4 meter
		530 * Green	CC + \$50 Clear Cover	SC8 + \$50 Standard Cable 8 meter
		660 + \$0 Red	SD + \$50 Standard Diffuser	SC15 + \$70 Standard Cable 15 meter
		880 + \$0 Infrared	TFD + \$50 Thin Film Diffuser	SC30 + \$110 Standard Cable 30 meter
		WHI * White	P + \$100 Polarizer	SCHF4 + \$75 Standard High Flex Cable 4 meter
				SCHF8 + \$100 Standard High Flex Cable 8 meter
				SCHF15 + \$150 Standard High Flex Cable 15 meter

Standard Dimensions

W 9"

L 25"

H .85"

*Call for pricing

BL1010 10" X 10" Back Light LED - Package Includes Light, and 4 Meter Cable	\$2650	470 + \$600 Blue	WD + \$0 White Diffuser	SC4 + \$0 Standard Cable 4 meter
		530 + \$600 Green	CC + \$50 Clear Cover	SC8 + \$50 Standard Cable 8 meter
		660 + \$0 Red	SD + \$50 Standard Diffuser	SC15 + \$70 Standard Cable 15 meter
		880 + \$0 Infrared	TFD + \$50 Thin Film Diffuser	SC30 + \$110 Standard Cable 30 meter
		WHI + \$600 White	P + \$100 Polarizer	SCHF4 + \$75 Standard High Flex Cable 4 meter
				SCHF8 + \$100 Standard High Flex Cable 8 meter
				SCHF15 + \$150 Standard High Flex Cable 15 meter

Standard Dimensions

W 11"

L 11"

H .85"

Wgt 3.19 lbs

Back Lights
Diffused Axial
Dome Lights
Linear Lights
Oxy Lights
Ring Lights
Spot Lights
TriPod Lights
Washdown Lights
Controllers & Cables

Back Lights
Diffused Axial
Dome Lights
Linear Lights
Oxy Lights
Ring Lights
Spot Lights
TriPod Lights
Washdown Lights
Controllers & Cables

Standard-Series Back Lights

Features:

- M12 connector for quick disconnect
- High speed built-in strobe
- 24VDC
- No driver/controller required
- Available in 4 colors and Infrared (IR)
- Available in 25+ sizes plus custom
- 10 Year Warranty* - 100,000 hours

Backlights run directly on 24 VDC and have strobe control. Backlights come with a standard 4 pin m12 connector. Spectrum Illumination Standard Series Lights are engineered to provide up to 100,000 hours of trouble free operation.

To Order, Specify;

1 Base Part Number	BL1212
Example:	\$3100
2 Specify LED Color	660
	+ \$0
3 Specify Diffuser Type	WD
	+ \$0
4 Specify Cable Option	SC4
	+ \$0

1 Base Part Number	List Price	2 LED Color	3 Diffuser Type	4 Cable Option
BL1212 12" X 12" Back Light LED - Package Includes Light, and 4 Meter Cable	\$3100	470 + \$600 Blue	WD + \$0 White Diffuser	SC4 + \$0 Standard Cable 4 meter
		530 + \$600 Green	CC + \$50 Clear Cover	SC8 + \$50 Standard Cable 8 meter
		660 + \$0 Red	SD + \$50 Standard Diffuser	SC15 + \$70 Standard Cable 15 meter
		880 + \$0 Infrared	TFD + \$50 Thin Film Diffuser	SC30 + \$110 Standard Cable 30 meter
		WHI + \$600 White	P + \$100 Polarizer	SCHF4 + \$75 Standard High Flex Cable 4 meter
				SCHF8 + \$100 Standard High Flex Cable 8 meter
				SCHF15 + \$150 Standard High Flex Cable 15 meter

Standard Dimensions	
W	13"
L	13"
H	.85"
Wgt	4.4 lbs



MACHINE VISION LIGHTING SINCE 1999

Monster-Series Back Lights



Spectrum Illumination's **Monster-Series Back Lights** are designed to create high contrast silhouettes for high speed Machine Vision Applications.



They can also be used to create diffused front lighting because of the high intensity of the LED's. These are 5-10 times brighter than the standard series depending on the color.

Units come with light, driver(s) / controller(s) and cable.

Series highlights

- External driver/controller included
- HS (high speed) strobe technology
- High Power LED's (24 VDC)
- DIN rail mount driver/controller
- M12 connector for quick disconnect
- Available in 4 colors and Infrared
- Available in 5 sizes
- 10 Year warranty* - 100,000 hours

Application examples

- Diffuse incident (front) lighting
- Diminish clear glass or plastic housings
- High speed bottling and canning operations
- Locate mounting holes
- Locate or measure outside dimensions
- Measure translucency
- View openings (e.g. drilled holes)

Units come with light, driver(s) / controller(s) and cable.

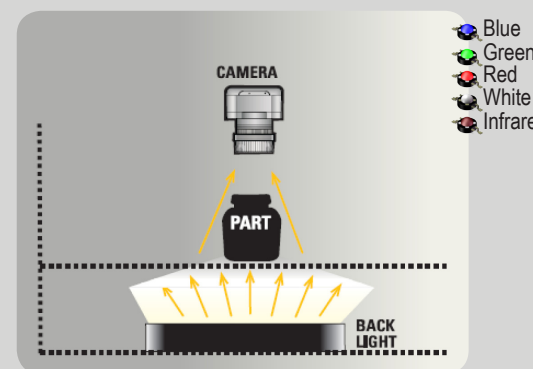

*10-Year warranty on registered products
 *6-Year warranty on non-registered products
 *3-year warranty on washdown lights
 spectrumillumination/limited-warranty/

P: (231) 894-4590
 E: sales@spectrumillumination.com

SpectrumIllumination.com

Monster-Series Back Lights

Features:

- External driver/controller included
- High speed strobe technology
- High power LED's (24 VDC)
- DIN rail mount driver/controller
- M12 connector for quick disconnect
- Available in 4 colors and Infrared
- 10 Year Warranty* - 100,000 hours

Caution –

The supplied LDM adapter must be used for both continuous or strobe operations! Do not connect the fixture directly to 24VDC! Operating the fixture without the supplied LDM adapter will result in premature LED failure and will void the warranty.

To Order, Specify;	
1 Base Part Number	
Example:	MBL22
	\$725
2 Specify LED Color	470
	\$0

1 Base Part Number	List Price	2 Specify LED Color
MBL22 2" X 2" Back Light LED - Package Includes Light, LDM 350/2, and 4 Meter Cable	\$725	470 + \$0 Blue 530 + \$0 Green 630 + \$0 Red 850 + \$0 Infrared WHI + \$0 White



Standard Dimensions

W 3"

L 3"

H 1.125"

Wgt .51 lbs

MBL24 2" X 4" Back Light LED - Package Includes Light, LDM 700, and 4 Meter Cable	\$975	470 + \$0 Blue 530 + \$0 Green 630 + \$0 Red 850 + \$0 Infrared WHI + \$0 White
---	--------------	---



Standard Dimensions

W 3"

L 5"

H 1"

Wgt .5 lbs

3 Specify Diffuser Type	4 Specify Cable Option	5 Specify Driver Option
WD \$0	MC4 \$0	A \$85

3 Specify Diffuser Type	4 Specify Cable Option	5 Specify Driver Option
WD + \$0 White Diffuser	MC4 + \$0 Monster Cable 4 meter	LDM350/2 + \$0 350mA 2-4 LED Driver DIN Rail Mount
CC + \$25 Clear Cover	MC8 + \$40 Monster Cable 8 meter	A + \$85 ALDM Driver
SD + \$25 Standard Diffuser	MC15 + \$60 Monster Cable 15 meter	V + \$85 VLDM Driver
TFD + \$25 Thin Film Diffuser	MC30 + \$195 Monster Cable 30 meter	RV + \$100 RVLDM Driver
P + \$25 Polarizer	MCHF4 + \$75 Monster High Flex Cable 4 meter	
	MCHF8 + \$100 Monster High Flex Cable 8 meter	
	MCHF15 + \$200 Monster High Flex Cable 15 meter	
	MCHF30 + \$380 Monster High Flex Cable 30 meter	

WD + \$0 White Diffuser	MC4 + \$0 Monster Cable 4 meter	LDM700 + \$0 700mA LED Driver DIN rail mount
CC + \$25 Clear Cover	MC8 + \$40 Monster Cable 8 meter	A + \$85 ALDM Driver
SD + \$25 Standard Diffuser	MC15 + \$60 Monster Cable 15 meter	V + \$85 VLDM Driver
TFD + \$25 Thin Film Diffuser	MC30 + \$195 Monster Cable 30 meter	RV + \$100 RVLDM Driver
P + \$25 Polarizer	MCHF4 + \$75 Monster High Flex Cable 4 meter	
	MCHF8 + \$100 Monster High Flex Cable 8 meter	
	MCHF15 + \$200 Monster High Flex Cable 15 meter	
	MCHF30 + \$380 Monster High Flex Cable 30 meter	

Back Lights
 Diffused Axial
 Dome Lights
 Linear Lights
 Oxy Lights
 Ring Lights
 Spot Lights
 TriPod Lights
 Washdown Lights
 Controllers & Cables

Back Lights
 Diffused Axial
 Dome Lights
 Linear Lights
 Oxy Lights
 Ring Lights
 Spot Lights
 TriPod Lights
 Washdown Lights
 Controllers & Cables

Monster-Series Back Lights



Features:

- External driver/controller included
- High speed strobe technology
- High power LED's (24 VDC)
- DIN rail mount driver/controller
- M12 connector for quick disconnect
- Available in 4 colors and Infrared
- 10 Year Warranty* - 100,000 hours

Caution –

The supplied LDM adapter must be used for both continuous or strobe operations! Do not connect the fixture directly to 24VDC! Operating the fixture without the supplied LDM adapter will result in premature LED failure and will void the warranty.

To Order, Specify;	
1 Base Part Number	
Example:	MBL44
	\$1275
2 Specify LED Color	470
	\$0

1 Base Part Number	List Price	2 Specify LED Color
MBL44 4" X 4" Back Light LED - Package Includes Light, LDM 1400, and 4 Meter Cable	\$1275	470 + \$0 Blue 530 + \$0 Green 630 + \$0 Red 850 + \$0 Infrared WHI + \$0 White
		
Standard Dimensions		
W 5"		
L 5"		
H 1"		
Wgt 1.25 lbs		
MBL46 4" X 6" Back Light LED - Package Includes Light, LDM 2100, and 4 Meter Cable	\$1700	470 + \$0 Blue 530 + \$0 Green 630 + \$0 Red 850 + \$0 Infrared WHI + \$0 White
		
Standard Dimensions		
W 5"		
L 7"		
H 1"		
Wgt 1.95 lbs		

3 Specify Diffuser Type	4 Specify Cable Option	5 Specify Driver Option
WD \$0	MC4 \$0	A \$85

3 Specify Diffuser Type	4 Specify Cable Option	5 Specify Driver Option
WD + \$0 White Diffuser	MC4 + \$0 Monster Cable 4 meter	LDM1400 + \$0 1400mA LED Driver DIN rail mount
CC + \$25 Clear Cover	MC8 + \$40 Monster Cable 8 meter	A + \$85 ALDM Driver
SD + \$25 Standard Diffuser	MC15 + \$60 Monster Cable 15 meter	V + \$85 VLDM Driver
TFD + \$25 Thin Film Diffuser	MC30 + \$195 Monster Cable 30 meter	RV + \$100 RVLDM Driver
P + \$25 Polarizer	MCHF4 + \$75 Monster High Flex Cable 4 meter	
	MCHF8 + \$100 Monster High Flex Cable 8 meter	
	MCHF15 + \$200 Monster High Flex Cable 15 meter	
	MCHF30 + \$380 Monster High Flex Cable 30 meter	
WD + \$0 White Diffuser	MC4 + \$0 Monster Cable 4 meter	LDM2100 + \$0 2100mA LED Driver DIN rail mount
CC + \$25 Clear Cover	MC8 + \$40 Monster Cable 8 meter	A + \$85 ALDM Driver
SD + \$25 Standard Diffuser	MC15 + \$60 Monster Cable 15 meter	V + \$85 VLDM Driver
TFD + \$25 Thin Film Diffuser	MC30 + \$195 Monster Cable 30 meter	RV + \$100 RVLDM Driver
P + \$25 Polarizer	MCHF4 + \$75 Monster High Flex Cable 4 meter	
	MCHF8 + \$100 Monster High Flex Cable 8 meter	
	MCHF15 + \$200 Monster High Flex Cable 15 meter	
	MCHF30 + \$380 Monster High Flex Cable 30 meter	

Back Lights
Diffused Axial
Dome Lights
Linear Lights
Oxy Lights
Ring Lights
Spot Lights
TriPod Lights
Washdown Lights
Controllers & Cables

Back Lights
Diffused Axial
Dome Lights
Linear Lights
Oxy Lights
Ring Lights
Spot Lights
TriPod Lights
Washdown Lights
Controllers & Cables

Monster-Series Back Lights

Features:

- External driver/controller included
- High speed strobe technology
- High power LED's (24 VDC)
- DIN rail mount driver/controller
- M12 connector for quick disconnect
- Available in 4 colors and Infrared
- 10 Year Warranty* - 100,000 hours

Caution –

The supplied LDM adapter must be used for both continuous or strobe operations! Do not connect the fixture directly to 24VDC! Operating the fixture without the supplied LDM adapter will result in premature LED failure and will void the warranty.

To Order, Specify;	
1 Base Part Number	
Example:	MBL48 \$2200
2 Specify LED Color	470 \$0

1 Base Part Number	List Price	2 Specify LED Color								
MBL48 4" X 8" Back Light LED - Package Includes Light, LDM 2800, and 4 Meter Cable	\$2200	470 + \$0 Blue 530 + \$0 Green 630 + \$0 Red 850 + \$0 Infrared WHI + \$0 White								
										
<p>Standard Dimensions</p> <table> <tr><td>W</td><td>5"</td></tr> <tr><td>L</td><td>9"</td></tr> <tr><td>H</td><td>1"</td></tr> <tr><td>Wgt</td><td>1.95 lbs</td></tr> </table>			W	5"	L	9"	H	1"	Wgt	1.95 lbs
W	5"									
L	9"									
H	1"									
Wgt	1.95 lbs									

3 Specify Diffuser Type	4 Specify Cable Option	5 Specify Driver Option
WD \$0	MC4 \$0	A \$85

3 Specify Diffuser Type	4 Specify Cable Option	5 Specify Driver Option
WD + \$0 White Diffuser	MC4 + \$0 Monster Cable 4 meter	LDM2800 + \$0 2800mA LED Driver DIN rail mount
CC + \$25 Clear Cover	MC8 + \$40 Monster Cable 8 meter	A + \$85 ALDM Driver
SD + \$25 Standard Diffuser	MC15 + \$60 Monster Cable 15 meter	V + \$85 VLDM Driver
TFD + \$25 Thin Film Diffuser	MC30 + \$195 Monster Cable 30 meter	RV + \$100 RVLDM Driver
P + \$25 Polarizer	MCHF4 + \$75 Monster High Flex Cable 4 meter	
	MCHF8 + \$100 Monster High Flex Cable 8 meter	
	MCHF15 + \$200 Monster High Flex Cable 15 meter	
	MCHF30 + \$380 Monster High Flex Cable 30 meter	

Monster-Series Back Lights

Features:

- External driver/controller included
- High speed Strobe Technology
- High Power LED's (24 VDC)
- DIN rail mount driver/controller
- M12 connector for quick disconnect
- Available in 8 colors, Ultra-Violet, Infrared
- Available in 14 sizes
- 10 Year Warranty* - 100,000 hours

Caution –

The supplied LDM adapter must be used for both continuous or strobe operations! Do not connect the fixture directly to 24VDC! Operating the fixture without the supplied LDM adapter will result in premature LED failure and will void the warranty.

To Order, Specify;			
1 Base Part Number	Example:		
	HBLL111.5	470	12
	\$1000	+ \$0	+ \$0
2 Specify LED Color	3 Specify Lens Type		

1 Base Part Number	List Price	2 Specify LED Color	3 Specify Lens Type
HBLL111.5 11.5" Linear Light LED with Extrusion Housing - Package includes light, LDM 700, and 4 meter cable	\$1000	365 + \$250 UV 365NM HB LED	12 + \$0 12 Degree Optics
		470 + \$0 Blue	16 + \$0 LED Optics 16 Frosted
Standard Dimensions		505 + \$0 Cyan	23 + \$0 LED Optics 23 Frosted
W 2.5"		530 + \$0 Green	30 + \$0 30 Degree Frosted Optics
L 12.5"		590 + \$0 Amber	39 + \$0 LED Optics 39 Frosted
H 1.205"		630 + \$0 Red	50 + \$0 50 Degree Optics
		850 + \$0 Infrared	F + \$0 Wide Angle Optics
		WHI + \$0 White	R + \$0 LED Reflector 90
		NWH + \$0 Natural White	R60 + \$0 LED Reflector 60
		WWH + \$0 Warm White	L + \$0 LED Optics Line

HBLL123 23" Linear Light LED with Extrusion Housing - Package includes light, LDM 1400, and 4 meter cable	\$1600	365 + \$500 UV 365NM HB LED	12 + \$0 12 Degree Optics
		470 + \$0 Blue	16 + \$0 LED Optics 16 Frosted
Standard Dimensions		505 + \$0 Cyan	23 + \$0 LED Optics 23 Frosted
W 2.5"		530 + \$0 Green	30 + \$0 30 Degree Frosted Optics
L 24"		590 + \$0 Amber	39 + \$0 LED Optics 39 Frosted
H 1.355"		630 + \$0 Red	50 + \$0 50 Degree Optics
		850 + \$0 Infrared	F + \$0 Wide Angle Optics
		WHI + \$0 White	R + \$0 LED Reflector 90
		NWH + \$0 Natural White	R60 + \$0 LED Reflector 60
		WWH + \$0 Warm White	L + \$0 LED Optics Line

4 Specify Diffuser Option	5 Specify Cable Option	6 Specify Driver Option
WD + \$0 White Diffuser	MC4 + \$0 Monster Cable 4 meter	A + \$85 700mA LED Driver DIN Rail Mount
CC + \$25 Clear Cover	MC8 + \$40 Monster Cable 8 meter	A + \$85 ALDM Driver
TFD + \$25 Thin Film Diffuser	MC15 + \$60 Monster Cable 15 meter	V + \$85 VLDM Driver
SD + \$25 Standard Diffuser	MC30 + \$195 Monster Cable 30 meter	RV + \$100 RVLDM Driver
P + \$50 Polarizer	MCHF4 + \$75 Monster High Flex Cable 4 meter	
	MCHF8 + \$100 Monster High Flex Cable 8 meter	
	MCHF15 + \$200 Monster High Flex Cable 15 meter	
	MCHF30 + \$380 Monster High Flex Cable 30 meter	

WD + \$0 White Diffuser	MC4 + \$0 Monster Cable 4 meter	LDM700 + \$0 700mA LED Driver DIN Rail Mount
CC + \$25 Clear Cover	MC8 + \$40 Monster Cable 8 meter	A + \$85 ALDM Driver
TFD + \$25 Thin Film Diffuser	MC15 + \$60 Monster Cable 15 meter	V + \$85 VLDM Driver
SD + \$25 Standard Diffuser	MC30 + \$195 Monster Cable 30 meter	RV + \$100 RVLDM Driver
P + \$50 Polarizer	MCHF4 + \$75 Monster High Flex Cable 4 meter	
	MCHF8 + \$100 Monster High Flex Cable 8 meter	
	MCHF15 + \$200 Monster High Flex Cable 15 meter	
	MCHF30 + \$380 Monster High Flex Cable 30 meter	

WD + \$0 White Diffuser	MC4 + \$0 Monster Cable 4 meter	LDM1400 + \$0 1400mA LED Driver DIN rail mount
CC + \$50 Clear Cover	MC8 + \$40 Monster Cable 8 meter	A + \$85 ALDM Driver
TFD + \$50 Thin Film Diffuser	MC15 + \$60 Monster Cable 15 meter	V + \$85 VLDM Driver
SD + \$50 Standard Diffuser	MC30 + \$195 Monster Cable 30 meter	RV + \$100 RVLDM Driver
P + \$75 Polarizer	MCHF4 + \$75 Monster High Flex Cable 4 meter	
	MCHF8 + \$100 Monster High Flex Cable 8 meter	
	MCHF15 + \$200 Monster High Flex Cable 15 meter	
	MCHF30 + \$380 Monster High Flex Cable 30 meter	

Monster-Series Back Lights

Features:

- External driver/controller included
- High speed Strobe Technology
- High Power LED's (24 VDC)
- DIN rail mount driver/controller
- M12 connector for quick disconnect
- Available in 8 colors, Ultra-Violet, Infrared
- Available in 14 sizes
- 10 Year Warranty* - 100,000 hours

Caution –

The supplied LDM adapter must be used for both continuous or strobe operations! Do not connect the fixture directly to 24VDC! Operating the fixture without the supplied LDM adapter will result in premature LED failure and will void the warranty.

To Order, Specify;

1 Base Part Number		
Example:	HBLL134.5	470
	\$2250	+ \$0
2 Specify LED Color		3 Specify Lens Type

1 Base Part Number	List Price	2 Specify LED Color	3 Specify Lens Type	
HBLL134.5 34.5" Linear Light LED with Extrusion Housing - Package includes light, LDM 2100, and 4 meter cable	\$2250	365 + \$750 UV 365NM HB LED	12 + \$0 12 Degree Optics	
		470 + \$0 Blue	16 + \$0 LED Optics 16 Frosted	
		505 + \$0 Cyan	23 + \$0 LED Optics 23 Frosted	
		530 + \$0 Green	30 + \$0 30 Degree Frosted Optics	
		590 + \$0 Amber	39 + \$0 LED Optics 39 Frosted	
		630 + \$0 Red	50 + \$0 50 Degree Optics	
		850 + \$0 Infrared	F + \$0 Wide Angle Optics	
		WHI + \$0 White	R + \$0 LED Reflector 90	
		NWH + \$0 Natural White	R60 + \$0 LED Reflector 60	
		WWH + \$0 Warm White	L + \$0 LED Optics Line	
		Standard Dimensions		
		W 2.5"		
		L 35.5"		
		H 1.355"		

4 Specify Diffuser Option	5 Specify Cable Option	6 Specify Driver Option
WD + \$0 White Diffuser	MC4 + \$0 Monster Cable 4 meter	A + \$85 2100mA LED Driver DIN rail mount
CC + \$50 Clear Cover	MC8 + \$40 Monster Cable 8 meter	A + \$85 ALDM Driver
TFD + \$50 Thin Film Diffuser	MC15 + \$60 Monster Cable 15 meter	V + \$85 VLDM Driver
SD + \$50 Standard Diffuser	MC30 + \$195 Monster Cable 30 meter	RV + \$100 RVLDM Driver
P + \$100 Polarizer	MCHF4 + \$75 Monster High Flex Cable 4 meter	
	MCHF8 + \$100 Monster High Flex Cable 8 meter	
	MCHF15 + \$200 Monster High Flex Cable 15 meter	
	MCHF30 + \$380 Monster High Flex Cable 30 meter	

4 Specify Diffuser Option	5 Specify Cable Option	6 Specify Driver Option
WD + \$0 White Diffuser	MC4 + \$0 Monster Cable 4 meter	LDM2100 + \$0 2100mA LED Driver DIN rail mount
CC + \$50 Clear Cover	MC8 + \$40 Monster Cable 8 meter	A + \$85 ALDM Driver
TFD + \$50 Thin Film Diffuser	MC15 + \$60 Monster Cable 15 meter	V + \$85 VLDM Driver
SD + \$50 Standard Diffuser	MC30 + \$195 Monster Cable 30 meter	RV + \$100 RVLDM Driver
P + \$100 Polarizer	MCHF4 + \$75 Monster High Flex Cable 4 meter	
	MCHF8 + \$100 Monster High Flex Cable 8 meter	
	MCHF15 + \$200 Monster High Flex Cable 15 meter	
	MCHF30 + \$380 Monster High Flex Cable 30 meter	

Monster-Series Back Lights

Features:

- External driver/controller included
- High speed Strobe Technology
- High Power LED's (24 VDC)
- DIN rail mount driver/controller
- M12 connector for quick disconnect
- Available in 8 colors, Ultra-Violet, Infrared
- Available in 14 sizes
- 10 Year Warranty* - 100,000 hours

Caution –

The supplied LDM adapter must be used for both continuous or strobe operations! Do not connect the fixture directly to 24VDC! Operating the fixture without the supplied LDM adapter will result in premature LED failure and will void the warranty.

To Order, Specify;			
1 Base Part Number			
Example:	MBLL146	470	12
	\$3150	+ \$0	+ \$0
2 Specify LED Color		3 Specify Lens Type	

1 Base Part Number	List Price	2 Specify LED Color	3 Specify Lens Type
MBLL146 46" Linear Light LED's - Package Includes Light, LDM 2800, and 4 Meter Cable	\$3150	365 + \$1000 UV 365NM HB LED 395 + \$60 UV 395NM HB LED 470 + \$0 Blue 505 + \$0 Cyan 530 + \$0 Green 630 + \$0 Red 850 + \$0 Infrared 940 + \$0 Infrared WHI + \$0 White NWH + \$0 Natural White WWH + \$0 Warm White	12 + \$0 12 Degree Optics 16 + \$0 LED Optics 16 Frosted 23 + \$0 LED Optics 23 Frosted 30 + \$0 30 Degree Frosted Optics 39 + \$0 LED Optics 39 Frosted 50 + \$0 50 Degree Optics F + \$0 Wide Angle Optics R + \$0 LED Reflector 90 R60 + \$0 LED Reflector 60 L + \$0 LED Optics Line

MBLL157.5 57.5" Linear Light LED's - Package Includes Light, LDM 3500, and 4 Meter Cable	\$4250	365 + \$1250 UV 365NM HB LED 395 + \$60 UV 395NM HB LED 470 + \$0 Blue 505 + \$0 Cyan 530 + \$0 Green 630 + \$0 Red 850 + \$0 Infrared 940 + \$0 Infrared WHI + \$0 White NWH + \$0 Natural White WWH + \$0 Warm White	12 + \$0 12 Degree Optics 16 + \$0 LED Optics 16 Frosted 23 + \$0 LED Optics 23 Frosted 30 + \$0 30 Degree Frosted Optics 39 + \$0 LED Optics 39 Frosted 50 + \$0 50 Degree Optics F + \$0 Wide Angle Optics R + \$0 LED Reflector 90 R60 + \$0 LED Reflector 60 L + \$0 LED Optics Line
--	---------------	--	---

4 Specify Diffuser Option	5 Specify Cable Option	6 Specify Driver Option
WD + \$0 White Diffuser	MC4 + \$0 Monster Cable 4 meter	A + \$85 2800mA LED Driver DIN rail mount

4 Specify Diffuser Option	5 Specify Cable Option	6 Specify Driver Option
WD + \$0 White Diffuser CC + \$75 Clear Cover TFD + \$75 Thin Film Diffuser SD + \$75 Standard Diffuser P + \$125 Polarizer	MC4 + \$0 Monster Cable 4 meter MC8 + \$40 Monster Cable 8 meter MC15 + \$60 Monster Cable 15 meter MC30-HO/6 * Monster Cable High Output 15 meter MCHF4 + \$75 Monster High Flex Cable 4 meter MCHF8 + \$100 Monster High Flex Cable 8 meter MCHF15 + \$200 Monster High Flex Cable 15 meter MCHF30-HO/6 * Monster High Flex High Output 30 meter cable	LDM2800 + \$0 2800mA LED Driver DIN rail mount A + \$85 ALDM Driver V + \$85 VLDM Driver RV + \$100 RVLDM Driver

WD + \$0 White Diffuser CC + \$100 Clear Cover TFD + \$100 Thin Film Diffuser SD + \$100 Standard Diffuser P + \$150 Polarizer	MC4 + \$0 Monster Cable 4 meter MC8 + \$40 Monster Cable 8 meter MC15 + \$60 Monster Cable 15 meter MC30-HO/6 * Monster Cable High Output 15 meter MCHF4 + \$75 Monster High Flex Cable 4 meter MCHF8 + \$100 Monster High Flex Cable 8 meter MCHF15 + \$200 Monster High Flex Cable 15 meter MCHF30-HO/6 * Monster High Flex High Output 30 meter cable	LDM3500 + \$0 3500mA LED Driver DIN rail mount A + \$85 ALDM Driver V + \$85 VLDM Driver RV + \$100 RVLDM Driver
--	---	---

Monster-Series Back Lights

Features:

- External driver/controller included
- High speed Strobe Technology
- High Power LED's (24 VDC)
- DIN rail mount driver/controller
- M12 connector for quick disconnect
- Available in 8 colors, Ultra-Violet, Infrared
- Available in 14 sizes
- 10 Year Warranty* - 100,000 hours

Caution –

The supplied LDM adapter must be used for both continuous or strobe operations! Do not connect the fixture directly to 24VDC! Operating the fixture without the supplied LDM adapter will result in premature LED failure and will void the warranty.

To Order, Specify;			
1 Base Part Number			
Example:	MBLL169	470	12
	\$5350	+ \$0	+ \$0
2 Specify LED Color		3 Specify Lens Type	

1 Base Part Number	List Price	2 Specify LED Color	3 Specify Lens Type
MBLL169 69" Linear Light LED's - Package Includes Light, LDM 4200, and 4 Meter Cable	\$5350	365 + \$1500 UV 365NM HB LED 395 + \$60 UV 395NM HB LED 470 + \$0 Blue 505 + \$0 Cyan 530 + \$0 Green 630 + \$0 Red 850 + \$0 Infrared 940 + \$0 Infrared WHI + \$0 White NWH + \$0 Natural White WWH + \$0 Warm White	12 + \$0 12 Degree Optics 16 + \$0 LED Optics 16 Frosted 23 + \$0 LED Optics 23 Frosted 30 + \$0 30 Degree Frosted Optics 39 + \$0 LED Optics 39 Frosted 50 + \$0 50 Degree Optics F + \$0 Wide Angle Optics R + \$0 LED Reflector 90 R60 + \$0 LED Reflector 60 L + \$0 LED Optics Line



Standard Dimensions	
W	3.8"
L	72.25"
H	3.5"
Wgt	17.35 lbs

MBLL180.5 80.5" Linear Light LED - Package Includes Light, LDM 4900, and 4 Meter Cable	\$5450	365 * Call for price UV 365NM HB LED 395 + \$60 UV 395NM HB LED 470 + \$0 Blue 505 + \$0 Cyan 530 + \$0 Green 630 + \$0 Red 850 + \$0 Infrared 940 + \$0 Infrared WHI + \$0 White NWH + \$0 Natural White WWH + \$0 Warm White	12 + \$0 12 Degree Optics 16 + \$0 LED Optics 16 Frosted 23 + \$0 LED Optics 23 Frosted 30 + \$0 30 Degree Frosted Optics 39 + \$0 LED Optics 39 Frosted 50 + \$0 50 Degree Optics F + \$0 Wide Angle Optics R + \$0 LED Reflector 90 R60 + \$0 LED Reflector 60 L + \$0 LED Optics Line
--	---------------	--	---



Standard Dimensions	
W	3.8"
L	83.75"
H	3.5"

4 Specify Diffuser Option	5 Specify Cable Option	6 Specify Driver Option
WD + \$0	MC4 + \$0	A + \$85

4 Specify Diffuser Option	5 Specify Cable Option	6 Specify Driver Option
WD + \$0 White Diffuser CC + \$125 Clear Cover SD + \$125 Standard Diffuser	MC4-HO/6 + \$0 Monster Cable High Output 4 meter MC8-HO/6 + \$150 Monster Cable High Output 8 meter MC15-HO/6+ \$200 Monster Cable High Output 15 meter MC30-HO/6 * Monster Cable High Output 15 meter MCHF4-HO/6 * Monster High Flex High Output 4 meter cable MCHF8-HO/6 * Monster High Flex High Output 8 meter cable MCHF15-HO/6 * Monster High Flex High Output 15 meter cable MCHF30-HO/6 * Monster High Flex High Output 30 meter cable	LDM4200 + \$0 4200mA LED Driver DIN rail mount A + \$85 ALDM Driver V + \$85 VLDM Driver RV + \$100 RVLDM Driver

*Call for pricing

WD + \$0 White Diffuser CC + \$150 Clear Cover SD + \$150 Standard Diffuser	MC4-HO/6 + \$0 Monster Cable High Output 4 meter MC8-HO/6 + \$150 Monster Cable High Output 8 meter MC15-HO/6+ \$200 Monster Cable High Output 15 meter MC30-HO/6 * Monster Cable High Output 15 meter MCHF4-HO/6 * Monster High Flex High Output 4 meter cable MCHF8-HO/6 * Monster High Flex High Output 8 meter cable MCHF15-HO/6 * Monster High Flex High Output 15 meter cable MCHF30-HO/6 * Monster High Flex High Output 30 meter cable	LDM4900 + \$0 4900 mA LED Driver DIN Rail Mount A + \$85 ALDM Driver V + \$85 VLDM Driver RV + \$100 RVLDM Driver
---	---	--

*Call for pricing

Diffused Axial

 [Monster-Series Diffused Axial Lights - External Driver Included](#) 35-36



MACHINE VISION LIGHTING SINCE 1999



Monster-Series Diffused Axial Lights

Spectrum Illumination's **Monster-Series Diffused Axial Lights** are built using a beam splitter to reflect the diffused light onto the field of view. The



reflected light from the area of interest is then able to pass through the beam splitter into the camera lens. Because the light is on the same axis as the camera and is diffused, the image from a shiny or uneven surface will not have any hot spots or shadows.

Units come with light, driver(s) / controller(s) and cable.

Series Highlights

- External driver/controller included
- HS (High Speed) Strobe Technology
- High Power LED's (24 VDC)
- DIN rail mount driver/controller
- M12 connector for quick disconnect
- Available in 8 colors and Infrared
- Available in 2 sizes
- 10 Year Warranty* - 100,000 hours

Application Examples

- Create contrast between specular, diffuse or absorptive surface
- Diminish visibility of clear overcoats or coverings
- Electronic component inspection fiducial location
- Enhance scribed, indented or embossed features
- Evenly illustrate flat, shiny surfaces

Units come with light, driver(s) / controller(s) and cable.

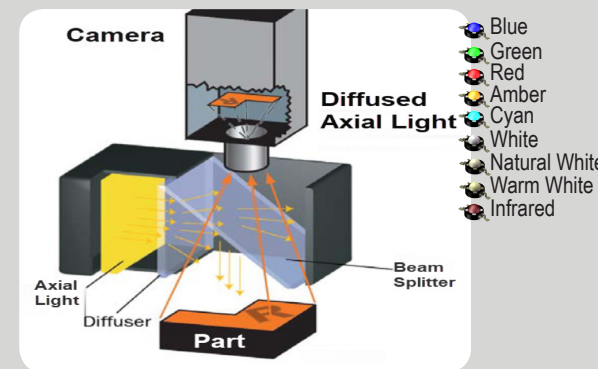

*10-Year warranty on registered products
 *6-Year warranty on non-registered products
 *3-year warranty on washdown lights
spectrumillumination.com/limited-warranty/

P: (231) 894-4590
 E: sales@spectrumillumination.com

SpectrumIllumination.com

Monster-Series Diffused Axial Lights



Features:

- External driver/controller included
- High speed strobe technology
- High power LED's (24 VDC)
- DIN rail mount driver/controller
- M12 connector for quick disconnect
- Available in 8 colors and Infrared
- Available in 2 sizes
- 10 Year Warranty* - 100,000 hours

Caution –

The supplied LDM adapter must be used for both continuous or strobe operations! Do not connect the fixture directly to 24VDC! Operating the fixture without the supplied LDM adapter will result in premature LED failure and will void the warranty.

To Order, Specify;	
① Base Part Number	MDA2
Example:	\$1000
② Specify LED Color	470 + \$0
③ Specify Cable Option	MC4 + \$0
④ Specify Driver Option	A + \$85



① Base Part Number	List Price	② LED Color	③ Cable Type	④ Driver Option
MDA2 2" Diffused Axial Light W/ LED - Package Includes Light, LDM 350/2, and 4 Meter Cable  Standard Dimensions W 2.25" L 2.209" H 4.145" Wgt .7 lbs	\$1000	470 + \$0 Blue	MC4 + \$0 Monster Cable 4 meter	LDM350/2 + \$0 350mA 2-4 LED Driver DIN Rail Mount
		505 + \$0 Cyan	MC8 + \$40 Monster Cable 8 meter	A + \$85 ALDM Driver
		530 + \$0 Green	MC15 + \$60 Monster Cable 15 meter	V + \$85 VLDM Driver
		590 + \$0 Amber	MC30 + \$195 Monster Cable 30 meter	RV + \$100 RVLDM Driver
		630 + \$0 Red	MCHF4 + \$75 Monster High Flex Cable 4 meter	
		850 + \$0 Infrared	MCHF8 + \$100 Monster High Flex Cable 8 meter	
		WHI + \$0 White	MCHF15 + \$200 Monster High Flex Cable 15 meter	
		NWH + \$0 Natural White	MCHF30 + \$380 Monster High Flex Cable 30 meter	
		WWH + \$0 Warm White		
		MDA4 4" Diffused Axial Light W/ LED - Package Includes Light, LDM 1400, and 4 Meter Cable  Standard Dimensions W 4.38" L 4.25" H 6.82" Wgt 3 lbs	\$2250	470 + \$0 Blue
505 + \$0 Cyan	MC8 + \$40 Monster Cable 8 meter			A + \$85 ALDM Driver
530 + \$0 Green	MC15 + \$60 Monster Cable 15 meter			V + \$85 VLDM Driver
590 + \$0 Amber	MC30 + \$195 Monster Cable 30 meter			RV + \$100 RVLDM Driver
630 + \$0 Red	MCHF4 + \$75 Monster High Flex Cable 4 meter			
850 + \$0 Infrared	MCHF8 + \$100 Monster High Flex Cable 8 meter			
WHI + \$0 White	MCHF15 + \$200 Monster High Flex Cable 15 meter			
NWH + \$200 Natural White	MCHF30 + \$380 Monster High Flex Cable 30 meter			
WWH + \$0 Warm White				

This page is intentionally blank

Back Lights
Diffused Axial
Dome Lights
Linear Lights
Oxy Lights
Ring Lights
Spot Lights
TriPod Lights
Washdown Lights
Controllers & Cables

Back Lights
Diffused Axial
Dome Lights
Linear Lights
Oxy Lights
Ring Lights
Spot Lights
TriPod Lights
Washdown Lights
Controllers & Cables

Dome Lights

	Monster-Series Multi-Channel Dome Lights - External Driver Included	39-43
	Monster-Series Multi-Channel Dome Lights - Internal Driver Included	45-51
	Monster-Series Dome Lights - External Driver Included	53-55



MACHINE VISION LIGHTING SINCE 1999



Monster-Series Multi-Channel Dome Lights

Spectrum Illumination's **Monster-Series Multi-Channel Dome Lights** can support 1-4 channels of LEDs and is used to create even lighting on shiny or uneven surfaces. This model is designed from light weight aluminum boards with a fiberglass dome to reflect multi angle light onto the field of view. Dome lights eliminate hotspots and shadows. Use our Diffused Axial Light to eliminate the appearance of the camera viewing port of the dome on "mirrored surfaces."



Units come with light, driver(s) / controller(s) and cable.

Units come with light, driver(s) / controller(s) and cable.

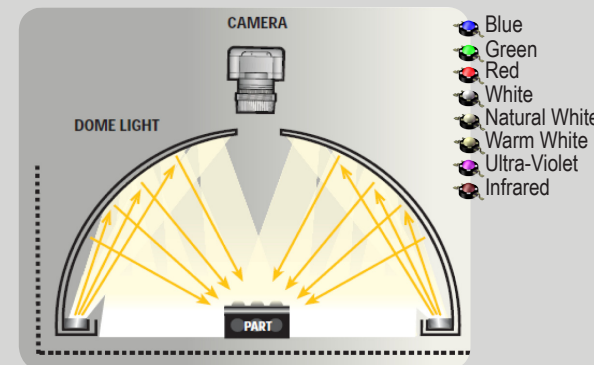

*10-Year warranty on registered products
 *6-Year warranty on non-registered products
 *3-year warranty on washdown lights
 spectrumillumination/limited-warranty/

Series Highlights

- External driver/controller included
- HS (High Speed) Strobe Technology
- High Power LED's (24 VDC)
- Support up to 4 preloaded LED color options
- Custom Color LED's available
- M12 connector for quick disconnect
- Available in 6 colors, Ultra-Violet, and Infrared
- Available in 1 size
- 10 Year Warranty* – 100,000 hours

Application Examples

- Automotive and aerospace processing
- Defects on surfaces
- Inspection
- Packaging
- Pharmaceutical

P: (231) 894-4590
 E: sales@spectrumillumination.com

SpectrumIllumination.com

Monster-Series Multi-Channel Dome Lights

Features:

- External driver/controller included
- High speed strobe technology
- High power LED's (24 VDC)
- Support up to 4 pre loaded LED colors
- Custom Color LED's available
- M12 connector for quick disconnect
- Available in 6 colors, Ultra-Violet, Infrared
- Available in 1 size
- 10 Year Warranty* - 100,000 hours

Caution –

The supplied LDM adapter must be used for both continuous or strobe operations! Do not connect the fixture directly to 24VDC! Operating the fixture without the supplied LDM adapter will result in premature LED failure and will void the warranty.

To Order, Specify;		
1 Base Part Number	DL180-XX	
Example:	\$2000	
2 Specify LED Color	B	G
	+ \$0	+ \$0

1 Base Part Number	List Price	2 Specify LED Color			
		Channel 1	Channel 2	Channel 3	Channel 4
DL180-X 180mm Dome Light With 1 Channel/Color LED's - Package Includes Light, VLDM 700 and 4 Meter Cable	\$1710	395 * UV 395NM HB LED			
	1 LED Color pick allowed	365 * UV 365NM HB LED			
Standard Dimensions		B + \$0 Blue			
W 14"		G + \$0 Green			
CC 43.96"		R + \$0 Red			
H 5.275"		850 + \$0 Infrared			
Wgt 2.85 lbs		940 + \$0 Infrared			
		W + \$0 White			
		NW + \$0 Natural White			
		WW + \$0 Warm White			
		*Call for pricing			

DL180-XX 180mm Dome Light With 2 Channel/Color LED's - Package Includes Light, 2 VLDM 700 and 4 Meter Cable	\$2000	395 * UV 395NM HB LED	395 * UV 395NM HB LED
	2 LED Color picks allowed	365 * UV 365NM HB LED	365 * UV 365NM HB LED
Standard Dimensions		B + \$0 Blue	B + \$0 Blue
W 14"		G + \$0 Green	G + \$0 Green
CC 43.96"		R + \$0 Red	R + \$0 Red
H 5.275"		850 + \$0 Infrared	850 + \$0 Infrared
Wgt 2.85 lbs		940 + \$0 Infrared	940 + \$0 Infrared
		W + \$0 White	W + \$0 White
		NW + \$0 Natural White	NW + \$0 Natural White
		WW + \$0 Warm White	WW + \$0 Warm White
		*Call for pricing	*Call for pricing

3 Specify Cable Type	4 Specify Driver Option
SC4-8 + \$0	V + \$0

3 Specify Cable Type	4 Specify Driver Option
SC4-8 + \$0 Standard Cable 4 meter 8 Wire	V + \$0 Standard VLDM Driver
SC8-8 + \$80 Standard Cable 8 meter 8 Wire	A + \$0 ALDM Driver
	RV + \$150 RVLDM Driver

SC4-8 + \$0 Standard Cable 4 meter 8 Wire	V + \$0 Standard VLDM Driver
SC8-8 + \$80 Standard Cable 8 meter 8 Wire	A + \$0 ALDM Driver
	RV + \$200 RVLDM Driver

Back Lights
Diffused Axial
Dome Lights
Linear Lights
Oxy Lights
Ring Lights
Spot Lights
TriPod Lights
Washdown Lights
Controllers & Cables

Back Lights
Diffused Axial
Dome Lights
Linear Lights
Oxy Lights
Ring Lights
Spot Lights
TriPod Lights
Washdown Lights
Controllers & Cables

Monster-Series Multi-Channel Dome Lights

Features:

- External driver/controller included
- High speed strobe technology
- High power LED's (24 VDC)
- Support up to 4 pre loaded LED colors
- Custom Color LED's available
- M12 connector for quick disconnect
- Available in 6 colors, Ultra-Violet, Infrared
- Available in 1 size
- 10 Year Warranty* - 100,000 hours

Caution –

The supplied LDM adapter must be used for both continuous or strobe operations! Do not connect the fixture directly to 24VDC! Operating the fixture without the supplied LDM adapter will result in premature LED failure and will void the warranty.

To Order, Specify;			
1 Base Part Number	DL180-XXX		
Example:	\$2300		
2 Specify LED Color	B	G	R
	+ \$0	+ \$0	+ \$0

1 Base Part Number	List Price	2 Specify LED Color			
		Channel 1	Channel 2	Channel 3	Channel 4
DL180-XXX 180mm Dome Light With 3 Channel/Color LED's - Package Includes Light, 3 VLDM 700 and 4 Meter Cable	\$2300	395 * UV 395NM HB LED	395 * UV 395NM HB LED	395 * UV 395NM HB LED	
	3 LED Color picks allowed	365 * UV 365NM HB LED	365 * UV 365NM HB LED	365 * UV 365NM HB LED	
		B + \$0 Blue	B + \$0 Blue	B + \$0 Blue	
		G + \$0 Green	G + \$0 Green	G + \$0 Green	
		R + \$0 Red	R + \$0 Red	R + \$0 Red	
		850 + \$0 Infrared	850 + \$0 Infrared	850 + \$0 Infrared	
		940 + \$0 Infrared	940 + \$0 Infrared	940 + \$0 Infrared	
		W + \$0 White	W + \$0 White	W + \$0 White	
		NW + \$0 Natural White	NW + \$0 Natural White	NW + \$0 Natural White	
		WW + \$0 Warm White	WW + \$0 Warm White	WW + \$0 Warm White	
				<i>*Call for pricing</i>	<i>*Call for pricing</i>

DL180-XXXX 180mm Dome Light With 4 Channel/Color LED's - Package Includes Light, 4 VLDM 700 and 4 Meter Cable	\$2550	395 * UV 395NM HB LED	395 * UV 395NM HB LED	395 * UV 395NM HB LED	395 * UV 395NM HB LED
	4 LED Color picks allowed	365 * UV 365NM HB LED	365 * UV 365NM HB LED	365 * UV 365NM HB LED	365 * UV 365NM HB LED
		B + \$0 Blue	B + \$0 Blue	B + \$0 Blue	B + \$0 Blue
		G + \$0 Green	G + \$0 Green	G + \$0 Green	G + \$0 Green
		R + \$0 Red	R + \$0 Red	R + \$0 Red	R + \$0 Red
		850 + \$0 Infrared	850 + \$0 Infrared	850 + \$0 Infrared	850 + \$0 Infrared
		940 + \$0 Infrared	940 + \$0 Infrared	940 + \$0 Infrared	940 + \$0 Infrared
		W + \$0 White	W + \$0 White	W + \$0 White	W + \$0 White
		NW + \$0 Natural White	NW + \$0 Natural White	NW + \$0 Natural White	NW + \$0 Natural White
		WW + \$0 Warm White	WW + \$0 Warm White	WW + \$0 Warm White	WW + \$0 Warm White
				<i>*Call for pricing</i>	<i>*Call for pricing</i>

3 Specify Cable Type	4 Specify Driver Option
SC4-8 + \$0	V + \$0

3 Specify Cable Type	4 Specify Driver Option
SC4-8 + \$0 Standard Cable 4 meter 8 Wire	V + \$0 Standard VLDM Driver
SC8-8 + \$80 Standard Cable 8 meter 8 Wire	A + \$0 ALDM Driver
	RV + \$300 RVLDM Driver

SC4-8 + \$0 Standard Cable 4 meter 8 Wire	V + \$0 Standard VLDM Driver
SC8-8 + \$80 Standard Cable 8 meter 8 Wire	A + \$0 ALDM Driver
	RV + \$400 RVLDM Driver

Back Lights
Diffused Axial
Dome Lights
Linear Lights
Oxy Lights
Ring Lights
Spot Lights
TriPod Lights
Washdown Lights
Controllers & Cables

Back Lights
Diffused Axial
Dome Lights
Linear Lights
Oxy Lights
Ring Lights
Spot Lights
TriPod Lights
Washdown Lights
Controllers & Cables

This page is intentionally blank



MACHINE VISION LIGHTING SINCE 1999

Monster-Series Multi-Channel Internal Driver Dome Lights



Spectrum Illumination's Monster-Series Multi-Channel Dome Lights can support 1-4 channels of LEDs and is used to create even lighting on shiny or uneven surfaces. This model is designed from light weight aluminum boards with a high impact dome to reflect multi angle light onto the field of view. Dome lights eliminate hot spots and shadows. Use our Diffused Axial Light to eliminate the appearance of the camera viewing port of the dome on "mirrored surfaces." DLD180 & DLD85 packages include light and cable.



Dome lights eliminate hot spots and shadows. Use our Diffused Axial Light to eliminate the appearance of the camera viewing port of the dome on "mirrored surfaces." DLD180 & DLD85 packages include light and cable.

Units come with light, driver(s) / controller(s) and cable.

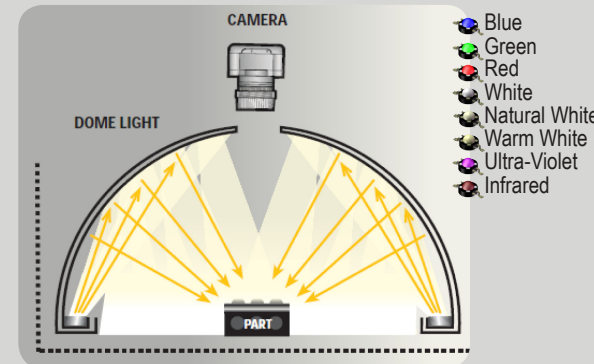

- *10-Year warranty on registered products
- *6-Year warranty on non-registered products
- *3-year warranty on washdown lights
- spectrumillumination.com/limited-warranty/

Series Highlights

- Internal driver - Plug & Play
- Auto Burst Technology
- High Power LED's (24 VDC)
- Support up to 4 preloaded LED color options
- Custom Color LED's available
- M12 connector for quick disconnect
- Available in 6 colors, Ultra-Violet & Infrared
- Available in 2 sizes 85mm & 180mm
- 0 - 10 VDC intensity Control
- Potentiometer Intensity Control
- 10 Year Warranty* - 100,000 hours

Application Examples

- Automotive and aerospace processing
- Defects on surfaces
- Inspection
- Packaging
- Pharmaceutical

P: (231) 894-4590
E: sales@spectrumillumination.com

SpectrumIllumination.com

Monster-Series Multi-Channel (Internal Driver) Dome Lights

Features:

- Internal Driver - Plug & Play
- Auto Burst Technology
- High power LED's (24 VDC)
- Supports up to 2 preloaded LED colors
- Custom Color LED's available
- M12 connector for quick disconnect
- Available in 6 colors and Infrared
- Available in 85mm and 180mm
- 0 - 10 VDC intensity Control
- Potentiometer Intensity Control
- 10 Year Warranty* - 100,000 hours

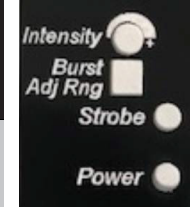

To Order, Specify;		
1 Base Part Number	DLD5-XX	
Example:	\$1200	
2 Specify LED Color	B	G
	+ \$0	+ \$0

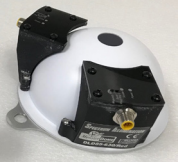
1 Base Part Number	List Price	2 Specify LED Color	
		Channel 1	Channel 2
DLD85-X 85mm Dome Light With 1 Channel/Color LED's - Package Includes Light and 3 Meter Cable 	\$900	B + \$0 Blue G + \$0 Green R + \$0 Red 850 * Infrared 940 * Infrared W + \$0 White NW + \$0 Natural White WW + \$0 Warm White *Call for pricing	
DLD85-XX 85mm Dome Light With 2 Channel/Color LED's - Package Includes Light and 3 Meter Cable 	\$1200	B + \$0 Blue G + \$0 Green R + \$0 Red 850 * Infrared 940 * Infrared W + \$0 White NW + \$0 Natural White WW + \$0 Warm White *Call for pricing	B + \$0 Blue G + \$0 Green R + \$0 Red 850 * Infrared 940 * Infrared W + \$0 White NW + \$0 Natural White WW + \$0 Warm White *Call for pricing

3 Specify Cable Type	
EC3	
+ \$0	

3 Specify Cable Type
EC3 + \$0
3M Cable
EC5 + \$15
5M Cable

EC3 + \$0
3M Cable
EC5 + \$15
5M Cable



Monster-Series Multi-Channel (Internal Driver) Dome Lights

Features:

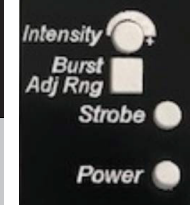
- Internal Driver - Plug & Play
- Auto Burst Technology
- High power LED's (24 VDC)
- Supports up to 4 preloaded LED colors
- Custom Color LED's available
- M12 connector for quick disconnect
- Available in 6 colors, Ultra-Violet, Infrared
- Available in 1 size
- 0 - 10 VDC intensity Control
- Potentiometer Intensity Control
- 10 Year Warranty* - 100,000 hours



To Order, Specify;	
1 Base Part Number	DLD180-XX
Example:	\$1900
2 Specify LED Color	B G
	+ \$0 + \$0

1 Base Part Number	List Price	2 Specify LED Color			
		Channel 1	Channel 2	Channel 3	Channel 4
DLD180-X 180mm Dome Light With 1 Channel/Color LED's - Package Includes Light and One-3 Meter Cable 	\$1650	395 * UV 395NM HB LED 365 * UV 365NM HB LED B + \$0 Blue G + \$0 Green R + \$0 Red 850 + \$0 Infrared 940 + \$0 Infrared W + \$0 White NW + \$0 Natural White WW + \$0 Warm White *Call for pricing			
DLD180-XX 180mm Dome Light With 2 Channel/Color LED's - Package Includes Light and Two-3 Meter Cables 	\$1900	395 * UV 395NM HB LED 365 * UV 365NM HB LED B + \$0 Blue G + \$0 Green R + \$0 Red 850 + \$0 Infrared 940 + \$0 Infrared W + \$0 White NW + \$0 Natural White WW + \$0 Warm White *Call for pricing	395 * UV 395NM HB LED 365 * UV 365NM HB LED B + \$0 Blue G + \$0 Green R + \$0 Red 850 + \$0 Infrared 940 + \$0 Infrared W + \$0 White NW + \$0 Natural White WW + \$0 Warm White *Call for pricing		

3 Specify Cable Type	
EC3	
+ \$0	

3 Specify Cable Type	
EC3 + \$0	
3M Cable	
EC5 + \$15	
5M Cable	
EC3 + \$0	
3M Cable	
EC5 + \$30	
5M Cable	



Monster-Series Multi-Channel (Internal Driver) Dome Lights

Features:

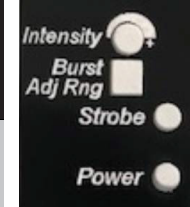
- Internal Driver - Plug & Play
- Auto Burst Technology
- High power LED's (24 VDC)
- Supports up to 4 preloaded LED colors
- Custom Color LED's available
- M12 connector for quick disconnect
- Available in 6 colors, Ultra-Violet, Infrared
- Available in 1 size
- 0 - 10 VDC intensity Control
- Potentiometer Intensity Control
- 10 Year Warranty* - 100,000 hours



To Order, Specify;			
1 Base Part Number	DLD180-XXX		
Example:	\$2200		
2 Specify LED Color	B	G	R
	+ \$0	+ \$0	+ \$0

1 Base Part Number	List Price	2 Specify LED Color			
		Channel 1	Channel 2	Channel 3	Channel 4
DLD180-XXX 180mm Dome Light With 3 Channel/Color LED's - Package Includes Light and Three-3 Meter Cables  3 LED Color picks available Standard Dimensions W 14" CC 43.96" H 5.275" Wgt 6.05 lbs	\$2200	395 * UV 395NM HB LED	395 * UV 395NM HB LED	395 * UV 395NM HB LED	
		365 * UV 365NM HB LED	365 * UV 365NM HB LED	365 * UV 365NM HB LED	
		B + \$0 Blue	B + \$0 Blue	B + \$0 Blue	
		G + \$0 Green	G + \$0 Green	G + \$0 Green	
		R + \$0 Red	R + \$0 Red	R + \$0 Red	
		850 + \$0 Infrared	850 + \$0 Infrared	850 + \$0 Infrared	
		940 + \$0 Infrared	940 + \$0 Infrared	940 + \$0 Infrared	
		W + \$0 White	W + \$0 White	W + \$0 White	
		NW + \$0 Natural White	NW + \$0 Natural White	NW + \$0 Natural White	
		WW + \$0 Warm White	WW + \$0 Warm White	WW + \$0 Warm White	
		*Call for pricing	*Call for pricing	*Call for pricing	
DLD180-XXXX 180mm Dome Light With 4 Channel/Color LED's - Package Includes Light and Four-3 Meter Cables  4 LED Color picks available Standard Dimensions W 14" CC 43.96" H 5.275" Wgt 6.05 lbs	\$2450	395 * UV 395NM HB LED	395 * UV 395NM HB LED	395 * UV 395NM HB LED	395 * UV 395NM HB LED
		365 * UV 365NM HB LED	365 * UV 365NM HB LED	365 * UV 365NM HB LED	365 * UV 365NM HB LED
		B + \$0 Blue	B + \$0 Blue	B + \$0 Blue	B + \$0 Blue
		G + \$0 Green	G + \$0 Green	G + \$0 Green	G + \$0 Green
		R + \$0 Red	R + \$0 Red	R + \$0 Red	R + \$0 Red
		850 + \$0 Infrared	850 + \$0 Infrared	850 + \$0 Infrared	850 + \$0 Infrared
		940 + \$0 Infrared	940 + \$0 Infrared	940 + \$0 Infrared	940 + \$0 Infrared
		W + \$0 White	W + \$0 White	W + \$0 White	W + \$0 White
		NW + \$0 Natural White	NW + \$0 Natural White	NW + \$0 Natural White	NW + \$0 Natural White
		WW + \$0 Warm White	WW + \$0 Warm White	WW + \$0 Warm White	WW + \$0 Warm White
		*Call for pricing	*Call for pricing	*Call for pricing	*Call for pricing

3 Specify Cable Type	
	EC3 + \$0

3 Specify Cable Type	
	EC3 + \$0 3M Cable EC5 + \$45 5M Cable
	EC3 + \$0 3M Cable EC5 + \$60 5M Cable

This page is intentionally blank



MACHINE VISION LIGHTING SINCE 1999

Monster-Series Dome Lights



Spectrum Illumination's **Monster-Series Dome Lights** are used to create even lighting on shiny or uneven surfaces. This model is designed from light weight fiberglass to reflect multi angle light onto the field of view.. Dome lights eliminate hotspots and shadows. Use our Diffused Axial Light to eliminate the appearance of the camera viewing port of the dome on "mirrored surfaces."



weight fiberglass to reflect multi angle light onto the field of view.. Dome lights eliminate hotspots and shadows. Use our Diffused Axial Light to eliminate the appearance of the camera viewing port of the dome on "mirrored surfaces."

Units come with light, driver(s) / controller(s) and cable.

Series Highlights

- External driver/controller included
- HS (High Speed) Strobe Technology
- High Power LED's (24 VDC)
- Custom Color LED's available
- Multi-channel option (DL-180) available
- M12 connector for quick disconnect
- Available in 6 colors, Ultra-Violet, and Infrared
- Available in 4 sizes
- 10 Year Warranty* – 100,000 hours

Application Examples

- Automotive and aerospace processing
- Defects on surfaces
- Inspection
- Packaging
- Pharmaceutical

Units come with light, driver(s) / controller(s) and cable.

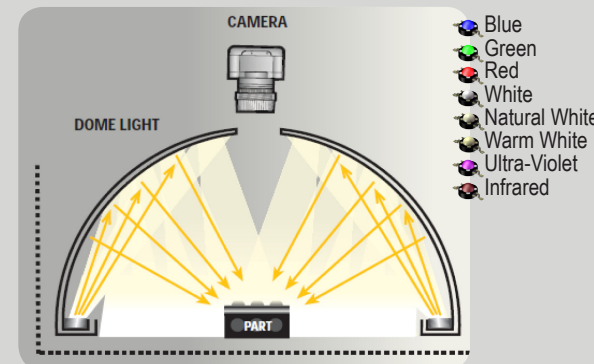

*10-Year warranty on registered products
 *6-Year warranty on non-registered products
 *3-year warranty on washdown lights
 spectrumillumination/limited-warranty/

P: (231) 894-4590
 E: sales@spectrumillumination.com

SpectrumIllumination.com

Monster-Series Dome Lights

- Features:
- External driver/controller included
 - High speed strobe technology
 - High power LED's (24 VDC)
 - Custom Color LED's available
 - Multi-channel option (DL-180) available
 - M12 connector for quick disconnect
 - Available in 6 colors,Ultra-Violet,Infrared
 - Available in 4 sizes
 - 10 Year Warranty* - 100,000 hours

Caution –
The supplied LDM adapter must be used for both continuous or strobe operations! Do not connect the fixture directly to 24VDC! Operating the fixture without the supplied LDM adapter will result in premature LED failure and will void the warranty.

To Order, Specify;	
① Base Part Number	MDL7.25
Example:	\$2000
② Specify LED Color	365 + \$200
③ Specify Cable Option	MC4 + \$0
④ Specify Driver Option	A + \$85

① Base Part Number	List Price	② LED Color	③ Cable Type	④ Driver Option
MDL7.25 7.25" Dome Light LED's - Package Includes Light, LDM 700, and 4 Meter Cable	\$2000	365 + \$200 UV 365NM HB LED 395 + \$200 UV 395NM HB LED 470 + \$0 Blue 505 + \$0 Cyan 530 + \$0 Green 590 + \$0 Amber 630 + \$0 Red 850 + \$0 Infrared 940 + \$0 Infrared WHI + \$0 White NWH + \$0 Natural White WWH + \$0 Warm White	MC4 + \$0 Monster Cable 4 meter MC8 + \$40 Monster Cable 8 meter MC15 + \$60 Monster Cable 15 meter MC30 + \$195 Monster Cable 30 meter MCHF4 + \$75 Monster High Flex Cable 4 meter MCHF8 + \$100 Monster High Flex Cable 8 meter MCHF15 + \$200 Monster High Flex Cable 15 meter MCHF30 + \$380 Monster High Flex Cable 30 meter	LDM700 + \$0 700mA LED Driver DIN Rail Mount A + \$85 ALDM Driver V + \$85 VLDM Driver RV + \$100 RVLDM Driver



Standard Dimensions

W	15"
CC	47.1"
H	6.225"
Wgt	6.01 lbs

MDL12.25 12.25" Dome Light LED's - Package Includes Light, LDM 1400, and 4 Meter Cable	\$2400	365 *Call for price UV 365NM HB LED 395 *Call for price UV 395NM HB LED 470 + \$0 Blue 505 + \$0 Cyan 530 + \$0 Green 590 + \$0 Amber 630 + \$0 Red 850 + \$0 Infrared 940 + \$0 Infrared WHI + \$0 White NWH + \$0 Natural White WWH + \$0 Warm White	MC4 + \$0 Monster Cable 4 meter MC8 + \$40 Monster Cable 8 meter MC15 + \$60 Monster Cable 15 meter MC30 + \$195 Monster Cable 30 meter MCHF4 + \$75 Monster High Flex Cable 4 meter MCHF8 + \$100 Monster High Flex Cable 8 meter MCHF15 + \$200 Monster High Flex Cable 15 meter MCHF30 + \$380 Monster High Flex Cable 30 meter	LDM1400 + \$0 1400mA LED Driver DIN Rail Mount A + \$85 ALDM Driver V + \$85 VLDM Driver RV + \$100 RVLDM Driver
--	---------------	---	---	---



Standard Dimensions

W	20"
CC	62.8"
H	8.725"
Wgt	9 lbs

Monster-Series Dome Lights

- Features:
- External driver/controller included
 - High speed strobe technology
 - High power LED's (24 VDC)
 - Custom Color LED's available
 - Multi-channel option (DL-180) available
 - M12 connector for quick disconnect
 - Available in 6 colors,Ultra-Violet,Infrared
 - Available in 4 sizes
 - 10 Year Warranty* - 100,000 hours

Caution –
The supplied LDM adapter must be used for both continuous or strobe operations! Do not connect the fixture directly to 24VDC! Operating the fixture without the supplied LDM adapter will result in premature LED failure and will void the warranty.

To Order, Specify;	
① Base Part Number	MDL18.25
Example:	\$550
② Specify LED Color	470 + \$0
③ Specify Cable Type	MC4 + \$0
④ Specify Driver Option	A + \$85

① Base Part Number	List Price	② LED Color	③ Cable Type	④ Driver Option
MDL18.25 18.25" Dome Light LED's - Package Includes Light, LDM 2100, and 4 Meter Cable	\$3550	365 *Call for price UV 365NM HB LED 395 *Call for price UV 365NM HB LED 470 + \$0 Blue 505 + \$0 Cyan 530 + \$0 Green 590 + \$0 Amber 630 + \$0 Red 850 + \$0 Infrared 940 + \$0 Infrared WHI + \$0 White NWH + \$0 Natural White WWH + \$0 Warm White	MC4 + \$0 Monster Cable 4 meter MC8 + \$40 Monster Cable 8 meter MC15 + \$60 Monster Cable 15 meter MC30 + \$195 Monster Cable 30 meter MCHF4 + \$75 Monster High Flex Cable 4 meter MCHF8 + \$100 Monster High Flex Cable 8 meter MCHF15 + \$200 Monster High Flex Cable 15 meter MCHF30 + \$380 Monster High Flex Cable 30 meter	LDM2100 + \$0 2100mA LED Driver DIN Rail Mount A + \$85 ALDM Driver V + \$85 VLDM Driver RV + \$100 RVLDM Driver



Standard Dimensions

W	23.125"
CC	72.612"
H	11.225"
Wgt	14 lbs

MDL29.25 29.25" Dome Light LED's - Package Includes Light, LDM 2800, and 4 Meter Cable	\$5750	365 *Call for price UV 365NM HB LED 395 *Call for price UV 395NM HB LED 470 + \$0 Blue 505 + \$0 Cyan 530 + \$0 Green 590 + \$0 Amber 630 + \$0 Red 850 + \$0 Infrared 940 + \$0 Infrared WHI + \$0 White NWH + \$0 Natural White WWH + \$0 Warm White	MC4 + \$0 Monster Cable 4 meter MC8 + \$40 Monster Cable 8 meter MC15 + \$60 Monster Cable 15 meter MC30 + \$195 Monster Cable 30 meter MCHF4 + \$75 Monster High Flex Cable 4 meter MCHF8 + \$100 Monster High Flex Cable 8 meter MCHF15 + \$200 Monster High Flex Cable 15 meter MCHF30 + \$380 Monster High Flex Cable 30 meter	LDM2800 + \$0 2800mA LED Driver DIN Rail Mount A + \$85 ALDM Driver V + \$85 VLDM Driver RV + \$100 RVLDM Driver
--	---------------	---	---	---



Standard Dimensions

Dia	34"
CC	106.76"
H	17.125"

Linear Lights

 Standard-Series Linear "Bright Field" Lights - No Driver Required	57-60
 E-Series Linear Lights - Internal Driver Included	61-65
 Monster-Series Linear "Bright Field" Lights - External Driver Included	67-89
 Monster-Series Linear "Bright Field" Lights - Internal Driver Included	91-95
 Monster-Series Xtreme Linear Lights - Internal Driver Included	96-97



MACHINE VISION LIGHTING SINCE 1999



Standard-Series Linear "Bright Field" Lights

Spectrum Illumination's Standard-Series Linear "Bright Field" Lights are designed to provide high-intensity illumination of large areas, at long distances.



Units come with light and cable.

Series Highlights

- No driver/controller required
- HS (High Speed) Strobe Technology
- 24 VDC
- M12 connector for quick disconnect
- Available in Red and Infrared
- Available in 6 sizes
- 10 Year Warranty* - 100,000 hours

Units come with light and cable.

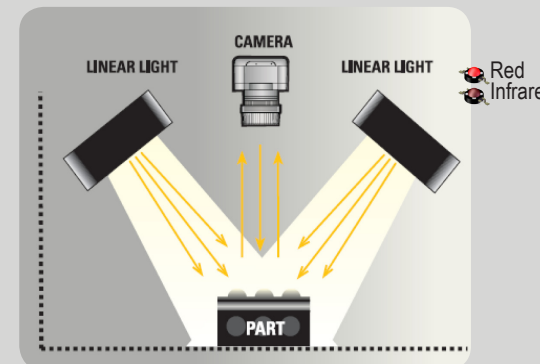
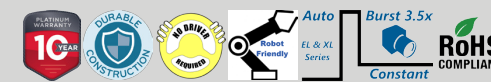

- *10-Year warranty on registered products
 - *6-Year warranty on non-registered products
 - *3-year warranty on washdown lights
- spectrumillumination/limited-warranty/

Application Examples

- Food and Beverage
- High speed bottling and canning operations
- Inspection
- Measure translucency
- Pharmaceutical
- Robotic Applications

P: (231) 894-4590
E: sales@spectrumillumination.com

SpectrumIllumination.com

Standard-Series Linear Lights

Features:

- No driver/controller required
- High speed built-in strobe
- 24VDC
- M12 connector for quick disconnect
- Available in Red and Infrared
- Available in 6 sizes
- 10 Year Warranty* - 100,000 hours

To Order, Specify;	
① Base Part Number	LA14
Example:	\$475
② Specify LED Color	630 + \$0
③ Specify Diffuser Type	SD + \$0
④ Specify Cable Option	SC4 + \$0

① Base Part Number	List Price	② LED Color	③ Diffuser Type	④ Cable Option
LA14 1" X 4" Linear Light LED - Package Includes Light, and 4 Meter Cable	\$475	630 + \$0 Red 880 + \$0 Infrared 950 + \$0 Infrared	SD + \$0 Standard Diffuser TFD + \$25 Thin Film Diffuser WD + \$25 White Diffuser P + \$25 Polarizer	SC4 + \$0 Standard Cable 4 meter SC8 + \$50 Standard Cable 8 meter SC15 + \$70 Standard Cable 15 meter SC30 + \$110 Standard Cable 30 meter SCHF4 + \$75 Standard High Flex Cable 4 meter SCHF8 + \$100 Standard High Flex Cable 8 meter SCHF15 + \$150 Standard High Flex Cable 15 meter
 <p>Standard Dimensions</p> <p>W 2" L 5" H 1.125" Wgt .55 lbs</p>				

LA18 1"X 8"Linear Light LED - Package Includes Light, and 4 Meter Cable	\$600	630 + \$0 Red 880 + \$0 Infrared	SD + \$0 Standard Diffuser TFD + \$25 Thin Film Diffuser WD + \$25 White Diffuser P + \$25 Polarizer	SC4 + \$0 Standard Cable 4 meter SC8 + \$50 Standard Cable 8 meter SC15 + \$70 Standard Cable 15 meter SC30 + \$110 Standard Cable 30 meter SCHF4 + \$75 Standard High Flex Cable 4 meter SCHF8 + \$100 Standard High Flex Cable 8 meter SCHF15 + \$150 Standard High Flex Cable 15 meter
 <p>Standard Dimensions</p> <p>W 2" L 9" H 1.125" Wgt .95 lbs</p>				

Standard-Series Linear Lights

Features:

- No driver/controller required
- High speed built-in strobe
- 24VDC
- M12 connector for quick disconnect
- Available in Red and Infrared
- Available in 6 sizes
- 10 Year Warranty* - 100,000 hours

To Order, Specify;	
① Base Part Number	LA112
Example:	\$950
② Specify LED Color	630 + \$0
③ Specify Diffuser Type	SD + \$0
④ Specify Cable Option	SC4 + \$0

① Base Part Number	List Price	② LED Color	③ Diffuser Type	④ Cable Option
LA112 1" X 12" Linear Light LED - Package Includes Light, and 4 Meter Cable	\$950	630 + \$0 Red 880 + \$0 Infrared	SD + \$0 Standard Diffuser TFD + \$25 Thin Film Diffuser WD + \$25 White Diffuser P + \$25 Polarizer	SC4 + \$0 Standard Cable 4 meter SC8 + \$50 Standard Cable 8 meter SC15 + \$70 Standard Cable 15 meter SC30 + \$110 Standard Cable 30 meter SCHF4 + \$75 Standard High Flex Cable 4 meter SCHF8 + \$100 Standard High Flex Cable 8 meter SCHF15 + \$150 Standard High Flex Cable 15 meter
 <p>Standard Dimensions</p> <p>W 2" L 13" H 1.125"</p>				

LA116 1" X 16" Linear Light LED - Package Includes Light, and 4 Meter Cable	\$1200	630 + \$0 Red 880 + \$0 Infrared	SD + \$0 Standard Diffuser TFD + \$25 Thin Film Diffuser WD + \$25 White Diffuser P + \$25 Polarizer	SC4 + \$0 Standard Cable 4 meter SC8 + \$50 Standard Cable 8 meter SC15 + \$70 Standard Cable 15 meter SC30 + \$110 Standard Cable 30 meter SCHF4 + \$75 Standard High Flex Cable 4 meter SCHF8 + \$100 Standard High Flex Cable 8 meter SCHF15 + \$150 Standard High Flex Cable 15 meter
 <p>Standard Dimensions</p> <p>W 2" L 17" H 1.125" Wgt 2.02 lbs</p>				

Standard-Series Linear Lights

Features:

- No driver/controller required
- High speed built-in strobe
- 24VDC
- M12 connector for quick disconnect
- Available in Red and Infrared
- Available in 6 sizes
- 10 Year Warranty* - 100,000 hours

To Order, Specify;

1 Base Part Number	LA124
Example:	\$1600
2 Specify LED Color	630
	+ \$0
3 Specify Diffuser Type	SD
	+ \$0
4 Specify Cable Option	SC4
	+ \$0

1 Base Part Number	List Price	2 LED Color	3 Diffuser Type	4 Cable Option
LA124 1" X 24" Linear Light LED - Package Includes Light, and 4 Meter Cable	\$1600	630 + \$0 Red	SD + \$0 Standard Diffuser	SC4 + \$0 Standard Cable 4 meter
		880 + \$0 Infrared	TFD + \$25 Thin Film Diffuser	SC8 + \$50 Standard Cable 8 meter
			WD + \$25 White Diffuser	SC15 + \$70 Standard Cable 15 meter
			P + \$25 Polarizer	SC30 + \$110 Standard Cable 30 meter
				SCHF4 + \$75 Standard High Flex Cable 4 meter
				SCHF8 + \$100 Standard High Flex Cable 8 meter
				SCHF15 + \$150 Standard High Flex Cable 15 meter
LA24 2"X 4" Linear Light LED - Package Includes Light, and 4 Meter Cable	\$600	630 + \$0 Red	SD + \$0 Standard Diffuser	SC4 + \$0 Standard Cable 4 meter
		880 + \$0 Infrared	TFD + \$25 Thin Film Diffuser	SC8 + \$50 Standard Cable 8 meter
			WD + \$25 White Diffuser	SC15 + \$70 Standard Cable 15 meter
			P + \$25 Polarizer	SC30 + \$110 Standard Cable 30 meter
				SCHF4 + \$75 Standard High Flex Cable 4 meter
				SCHF8 + \$100 Standard High Flex Cable 8 meter
				SCHF15 + \$150 Standard High Flex Cable 15 meter



Standard Dimensions

W	2"
L	25"
H	1.25"
Wgt	2.9 lbs



Standard Dimensions

W	3"
L	5"
H	1.125"
Wgt	.7 lbs



MACHINE VISION LIGHTING SINCE 1999



Spectrum Illumination's **E-Series Linear Lights** are used for both bright field and dark field illumination. E-Series Linear Lights have an aluminum circuit board and single interface housing to dissipate heat. E-Series Burst 3.5x capabilities are protected by an auto-resetting circuit.



Units come with light and cable.

Units come with light and cable.

Series Highlights

- Internal driver/controller included
- Auto Burst 3.5x Technology
- Thermal Protection to reduce downtime
- High Power LED's (24 VDC)
- M12 connector for quick disconnect
- Available in 4 colors, Ultra-Violet, and Infrared
- Available in 3 sizes and 40mm Spot Light
- 10 Year Warranty* - 50,000 hours

Units come with light and cable.

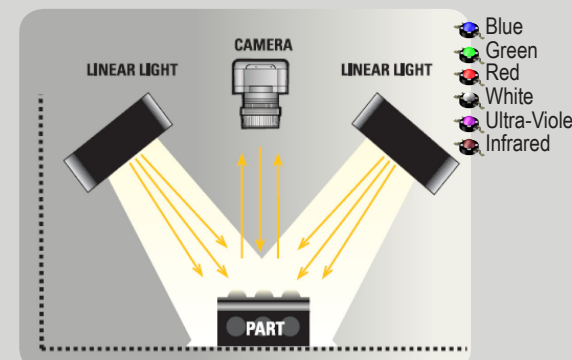

*10-Year warranty on registered products
 *6-Year warranty on non-registered products
 *3-year warranty on washdown lights
 spectrumillumination/limited-warranty/

Application Examples

- Automotive and aerospace processing
- Defects on surfaces
- Inspection
- Large surface inspection
- OCR Optical Character Reading
- Packaging
- Print control

P: (231) 894-4590
 E: sales@spectrumillumination.com

SpectrumIllumination.com

E-Series Linear Lights

Features:

- Internal driver/controller included
- Auto Burst 3.5x Technology
- Thermal Protection to reduce downtime
- High Power LED's (24 VDC)
- M12 connector for quick disconnect
- Available in 4 colors, Ultra-Violet, Infrared
- Available in 3 sizes and 40mm Spot Light
- 10 Year Warranty* - 50,000 hours

To Order, Specify;	
1 Base Part Number	
Example:	EL150
	\$475
2 Specify LED Color	470
	+ \$0

1 Base Part Number	List Price	2 Specify LED Color
EL150 E-Series 150mm Bar Light With LED's and 3 Meter Cable	\$475	365 *Call for price UV 365NM HB LED 395 + \$50 UV 395NM HB LED 470 + \$0 Blue 530 + \$0 Green 630 + \$0 Red 850 + \$0 Infrared 940 + \$50 Infrared WHI + \$0 White
		
Standard Dimensions		
W 1.506"		
L 8.799"		
H 1.181"		
Wgt .5 lbs		

EL300 E-Series 300mm Bar Light With LED's and 3 Meter Cable	\$650	365 + \$200 UV 365NM HB LED 395 + \$100 UV 395NM HB LED 470 + \$0 Blue 530 + \$0 Green 630 + \$0 Red 850 + \$0 Infrared 940 + \$100 Infrared WHI + \$0 White
		
Standard Dimensions		
W 1.506"		
L 14.705"		
H 1.181"		
Wgt .75 lbs		

3 Specify Lens Type	4 Specify Diffuser Option	5 Specify Cable Option
16 + \$0	CC + \$0	EC3 + \$0

16 + \$0 LED Optics 16 Frosted	CC + \$0 Clear Cover	EC3 + \$0 E-Series Cable 3M
23 + \$0 LED Optics 23 Frosted	SD + \$15 Standard Diffuser	EC5 + \$15 E-Series Cable 5M
39 + \$0 LED Optics 39 Frosted	TFD + \$15 Thin Film Diffuser	
R + \$0 LED Reflector 90	WD + \$15 White Diffuser	
R60 + \$0 LED Reflector 60	P + \$25 Polarizer	
L + \$0 LED Optics Line		

16 + \$0 LED Optics 16 Frosted	CC + \$0 Clear Cover	EC3 + \$0 E-Series Cable 3M
23 + \$0 LED Optics 23 Frosted	SD + \$25 Standard Diffuser	EC5 + \$15 E-Series Cable 5M
39 + \$0 LED Optics 39 Frosted	TFD + \$25 Thin Film Diffuser	
R + \$0 LED Reflector 90	WD + \$25 White Diffuser	
R60 + \$0 LED Reflector 60	P + \$50 Polarizer	
L + \$0 LED Optics Line		

E-Series Linear Lights

Features:

- Internal driver/controller included
- Auto Burst 3.5x Technology
- Thermal Protection to reduce downtime
- High Power LED's (24 VDC)
- M12 connector for quick disconnect
- Available in 4 colors, Ultra-Violet, Infrared
- Available in 3 sizes and 40mm Spot Light
- 10 Year Warranty* - 50,000 hours

To Order, Specify;	
1 Base Part Number	
Example:	EL2150
	\$675
2 Specify LED Color	470
	+ \$0

1 Base Part Number	List Price	2 Specify LED Color
EL2150 E-Series Double Row 150mm Bar Light LED's and 3 Meter Cable	\$675	395 + \$100 UV 395NM HB LED
		470 + \$0 Blue
		530 + \$0 Green
		630 + \$0 Red
		850 + \$0 Infrared
		940 + \$100 Infrared
		WHI + \$0 White
Standard Dimensions		
W 2.362"		
L 8.799"		
H 1.181"		
Wgt .5 lbs		

3 Specify Lens Type	4 Specify Diffuser Option	5 Specify Cable Option
16 + \$0	CC + \$0	EC3 + \$0

3 Specify Lens Type	4 Specify Diffuser Option	5 Specify Cable Option
16 + \$0 LED Optics 16 Frosted	CC + \$0 Clear Cover	EC3 + \$0 E-Series Cable 3M
23 + \$0 LED Optics 23 Frosted	SD + \$25 Standard Diffuser	EC5 + \$15 E-Series Cable 5M
39 + \$0 LED Optics 39 Frosted	TFD + \$25 Thin Film Diffuser	
R + \$0 LED Reflector 90	WD + \$25 White Diffuser	
R60 + \$0 LED Reflector 60	P + \$50 Polarizer	
L + \$0 LED Optics Line		

This page is intentionally blank



MACHINE VISION LIGHTING SINCE 1999



Monster-Series Linear “Bright Field” Lights

Spectrum Illumination’s Monster-Series Linear “Bright Field” Lights are designed to provide high-intensity illumination of large areas, at long distances.



Units come with light, driver(s) / controller(s) and cable.

Series Highlights

- External driver/controller included
- HS (High Speed) Strobe Technology
- High Power LED’s (24 VDC)
- DIN rail mount driver/controller
- M12 connector for quick disconnect
- Available in 8 colors, Ultra-Violet, and Infrared
- Available in 14 sizes
- 10 Year Warranty* - 100,000 hours

Units come with light, driver(s) / controller(s) and cable.

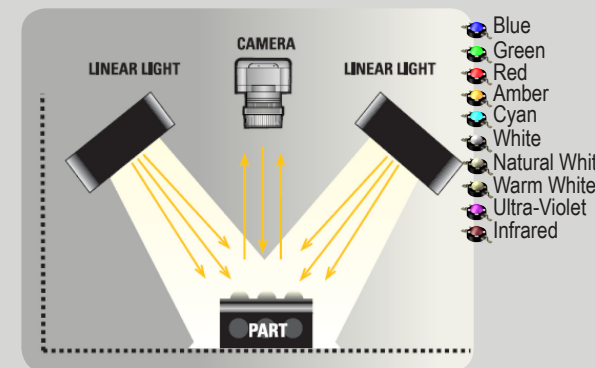

Application Examples

- Food and Beverage
- High speed bottling and canning operations
- Inspection
- Measure translucency
- Pharmaceutical
- Robotic Applications

- *10-Year warranty on registered products
 - *6-Year warranty on non-registered products
 - *3-year warranty on washdown lights
- spectrumillumination/limited-warranty/

P: (231) 894-4590
E: sales@spectrumillumination.com

SpectrumIllumination.com

Monster-Series Linear Lights

Features:

- External driver/controller included
- High speed Strobe Technology
- High Power LED's (24 VDC)
- DIN rail mount driver/controller
- M12 connector for quick disconnect
- Available in 8 colors, Ultra-Violet, Infrared
- Available in 14 sizes
- 10 Year Warranty* - 100,000 hours

Caution –

The supplied LDM adapter must be used for both continuous or strobe operations! Do not connect the fixture directly to 24VDC! Operating the fixture without the supplied LDM adapter will result in premature LED failure and will void the warranty.

To Order, Specify;			
1 Base Part Number			
Example:	MLL12	470	12
	\$430	+ \$0	+ \$0
2 Specify LED Color		3 Specify Lens Type	

1 Base Part Number	List Price	2 Specify LED Color	3 Specify Lens Type
MLL12 2" Linear Light LED's - Package Includes Light, LDM 350/2, and 4 Meter Cable	\$430	365 + \$50 UV 365NM HB LED 395 + \$20 UV 395NM HB LED 470 + \$0 Blue 505 + \$0 Cyan 530 + \$0 Green 630 + \$0 Red 850 + \$0 Infrared 940 + \$0 Infrared WHI + \$0 White NWH + \$0 Natural White WWH + \$0 Warm White	12 + \$0 12 Degree Optics 16 + \$0 LED Optics 16 Frosted 23 + \$0 LED Optics 23 Frosted 30 + \$0 30 Degree Frosted Optics 39 + \$0 LED Optics 39 Frosted 50 + \$0 50 Degree Optics F + \$0 Wide Angle Optics R + \$0 LED Reflector 90 R60 + \$0 LED Reflector 60 L + \$0 LED Optics Line

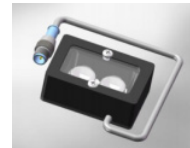

Standard Dimensions	
W	2"
L	3"
H	1.125"
Wgt	.4 lbs

MLL14 4" Linear Light LED's - Package Includes Light, LDM 350/2, and 4 Meter Cable	\$500	365 + \$100 UV 365NM HB LED 395 + \$60 UV 395NM HB LED 470 + \$0 Blue 505 + \$0 Cyan 530 + \$0 Green 630 + \$0 Red 850 + \$0 Infrared 940 + \$0 Infrared WHI + \$0 White NWH + \$0 Natural White WWH + \$0 Warm White	12 + \$0 12 Degree Optics 16 + \$0 LED Optics 16 Frosted 23 + \$0 LED Optics 23 Frosted 30 + \$0 30 Degree Frosted Optics 39 + \$0 LED Optics 39 Frosted 50 + \$0 50 Degree Optics F + \$0 Wide Angle Optics R + \$0 LED Reflector 90 R60 + \$0 LED Reflector 60 L + \$0 LED Optics Line
--	--------------	---	---



Standard Dimensions	
W	2"
L	5"
H	1.125"
Wgt	.6 lbs

4 Specify Diffuser Option	5 Specify Cable Option	6 Specify Driver Option
SD + \$0	MC4 + \$0	A + \$85

SD + \$0 Standard Diffuser	MC4 + \$0 Monster Cable 4 meter	LDM350/2 + \$0 350mA 2-4 LED Driver DIN Rail Mount
CC + \$25 Clear Cover	MC8 + \$40 Monster Cable 8 meter	A + \$85 ALDM Driver
TFD + \$25 Thin Film Diffuser	MC15 + \$60 Monster Cable 15 meter	V + \$85 VLDM Driver
WD + \$25 White Diffuser	MC30 + \$195 Monster Cable 30 meter	RV + \$100 RVLDM Driver
P + \$25 Polarizer	MCHF4 + \$75 Monster High Flex Cable 4 meter	
	MCHF8 + \$100 Monster High Flex Cable 8 meter	
	MCHF15 + \$200 Monster High Flex Cable 15 meter	
	MCHF30 + \$380 Monster High Flex Cable 30 meter	

SD + \$0 Standard Diffuser	MC4 + \$0 Monster Cable 4 meter	LDM350/2 + \$0 350mA 2-4 LED Driver DIN Rail Mount
CC + \$25 Clear Cover	MC8 + \$40 Monster Cable 8 meter	A + \$85 ALDM Driver
TFD + \$25 Thin Film Diffuser	MC15 + \$60 Monster Cable 15 meter	V + \$85 VLDM Driver
WD + \$25 White Diffuser	MC30 + \$195 Monster Cable 30 meter	RV + \$100 RVLDM Driver
P + \$25 Polarizer	MCHF4 + \$75 Monster High Flex Cable 4 meter	
	MCHF8 + \$100 Monster High Flex Cable 8 meter	
	MCHF15 + \$200 Monster High Flex Cable 15 meter	
	MCHF30 + \$380 Monster High Flex Cable 30 meter	

Monster-Series Linear Lights

Features:

- External driver/controller included
- High speed Strobe Technology
- High Power LED's (24 VDC)
- DIN rail mount driver/controller
- M12 connector for quick disconnect
- Available in 8 colors, Ultra-Violet, Infrared
- Available in 14 sizes
- 10 Year Warranty* - 100,000 hours

Caution –

The supplied LDM adapter must be used for both continuous or strobe operations! Do not connect the fixture directly to 24VDC! Operating the fixture without the supplied LDM adapter will result in premature LED failure and will void the warranty.

To Order, Specify;			
1 Base Part Number			
Example:	MLL16	395	12
	\$525	+ \$0	+ \$0
2 Specify LED Color		3 Specify Lens Type	

1 Base Part Number	List Price	2 Specify LED Color	3 Specify Lens Type
MLL16 6" Linear Light LED's - Package Includes Light, LDM 350/3 (LDM 350/2 For Ir), and 4 Meter Cable	\$525	365 + \$150 UV 365NM HB LED 395 + \$0 UV 395NM HB LED 470 + \$0 Blue 505 + \$0 Cyan 530 + \$0 Green 630 + \$0 Red 850 + \$0 Infrared 940 + \$0 Infrared WHI + \$0 White NWH + \$0 Natural White WWH + \$0 Warm White	12 + \$0 12 Degree Optics 16 + \$0 LED Optics 16 Frosted 23 + \$0 LED Optics 23 Frosted 30 + \$0 30 Degree Frosted Optics 39 + \$0 LED Optics 39 Frosted 50 + \$0 50 Degree Optics F + \$0 Wide Angle Optics R + \$0 LED Reflector 90 R60 + \$0 LED Reflector 60 L + \$0 LED Optics Line

MLL111.5 11.5" Linear Light LED's - Package Includes Light, LDM 700, and 4 Meter Cable	\$1000	365 + \$250 UV 365NM HB LED 395 + \$0 UV 395NM HB LED 470 + \$0 Blue 505 + \$0 Cyan 530 + \$0 Green 630 + \$0 Red 850 + \$0 Infrared 940 + \$0 Infrared WHI + \$0 White NWH + \$0 Natural White WWH + \$0 Warm White	12 + \$0 12 Degree Optics 16 + \$0 LED Optics 16 Frosted 23 + \$0 LED Optics 23 Frosted 30 + \$0 30 Degree Frosted Optics 39 + \$0 LED Optics 39 Frosted 50 + \$0 50 Degree Optics F + \$0 Wide Angle Optics R + \$0 LED Reflector 90 R60 + \$0 LED Reflector 60 L + \$0 LED Optics Line
--	---------------	--	---

4 Specify Diffuser Option	5 Specify Cable Option	6 Specify Driver Option
SD + \$0	MC4 + \$0	A + \$85

SD + \$0 Standard Diffuser	MC4 + \$0 Monster Cable 4 meter	LDM350/3 + \$0 350mA 5-6 LED Driver DIN Rail Mount
CC + \$25 Clear Cover	MC8 + \$40 Monster Cable 8 meter	A + \$85 ALDM Driver
TFD + \$25 Thin Film Diffuser	MC15 + \$60 Monster Cable 15 meter	V + \$85 VLDM Driver
WD + \$25 White Diffuser	MC30 + \$195 Monster Cable 30 meter	RV + \$100 RVLDM Driver
P + \$25 Polarizer	MCHF4 + \$75 Monster High Flex Cable 4 meter	
	MCHF8 + \$100 Monster High Flex Cable 8 meter	
	MCHF15 + \$200 Monster High Flex Cable 15 meter	
	MCHF30 + \$380 Monster High Flex Cable 30 meter	

SD + \$0 Standard Diffuser	MC4 + \$0 Monster Cable 4 meter	LDM700 + \$0 700mA LED Driver DIN Rail Mount
CC + \$25 Clear Cover	MC8 + \$40 Monster Cable 8 meter	A + \$85 ALDM Driver
TFD + \$25 Thin Film Diffuser	MC15 + \$60 Monster Cable 15 meter	V + \$85 VLDM Driver
WD + \$25 White Diffuser	MC30 + \$195 Monster Cable 30 meter	RV + \$100 RVLDM Driver
P + \$50 Polarizer	MCHF4 + \$75 Monster High Flex Cable 4 meter	
	MCHF8 + \$100 Monster High Flex Cable 8 meter	
	MCHF15 + \$200 Monster High Flex Cable 15 meter	
	MCHF30 + \$380 Monster High Flex Cable 30 meter	

Monster-Series Linear Lights

Features:

- External driver/controller included
- High speed Strobe Technology
- High Power LED's (24 VDC)
- DIN rail mount driver/controller
- M12 connector for quick disconnect
- Available in 8 colors, Ultra-Violet, Infrared
- Available in 14 sizes
- 10 Year Warranty* - 100,000 hours

Caution –

The supplied LDM adapter must be used for both continuous or strobe operations! Do not connect the fixture directly to 24VDC! Operating the fixture without the supplied LDM adapter will result in premature LED failure and will void the warranty.

To Order, Specify;			
1 Base Part Number	Example:		
	MLL117.25	395	12
	\$1250	+ \$0	+ \$0
2 Specify LED Color	3 Specify Lens Type		

1 Base Part Number	List Price	2 Specify LED Color	3 Specify Lens Type
MLL117.25 17.25" Linear Light LED's - Package Includes Light, LDM 1050, and 4 Meter Cable	\$1250	365 + \$350 UV 365NM HB LED 395 + \$0 UV 395NM HB LED 470 + \$0 Blue 505 + \$0 Cyan 530 + \$0 Green 630 + \$0 Red 850 + \$0 Infrared 940 + \$0 Infrared WHI + \$0 White NWH + \$0 Natural White WWH + \$0 Warm White	12 + \$0 12 Degree Optics 16 + \$0 LED Optics 16 Frosted 23 + \$0 LED Optics 23 Frosted 30 + \$0 30 Degree Frosted Optics 39 + \$0 LED Optics 39 Frosted 50 + \$0 50 Degree Optics F + \$0 Wide Angle Optics R + \$0 LED Reflector 90 R60 + \$0 LED Reflector 60 L + \$0 LED Optics Line

MLL123 23" Linear Light LED's - Package Includes Light, LDM 1400, and 4 Meter Cable	\$1600	365 + \$450 UV 365NM HB LED 395 + \$0 UV 395NM HB LED 470 + \$0 Blue 505 + \$0 Cyan 530 + \$0 Green 630 + \$0 Red 850 + \$0 Infrared 940 + \$0 Infrared WHI + \$0 White NWH + \$0 Natural White WWH + \$0 Warm White	12 + \$0 12 Degree Optics 16 + \$0 LED Optics 16 Frosted 23 + \$0 LED Optics 23 Frosted 30 + \$0 30 Degree Frosted Optics 39 + \$0 LED Optics 39 Frosted 50 + \$0 50 Degree Optics F + \$0 Wide Angle Optics R + \$0 LED Reflector 90 R60 + \$0 LED Reflector 60 L + \$0 LED Optics Line
--	---------------	--	---

4 Specify Diffuser Option	5 Specify Cable Option	6 Specify Driver Option
SD + \$0	MC4 + \$0	A + \$85

SD + \$0 Standard Diffuser	MC4 + \$0 Monster Cable 4 meter	LDM1050 + \$0 1050mA LED Driver DIN rail mount
CC + \$25 Clear Cover	MC8 + \$40 Monster Cable 8 meter	A + \$85 ALDM Driver
TFD + \$25 Thin Film Diffuser	MC15 + \$60 Monster Cable 15 meter	V + \$85 VLDM Driver
WD + \$25 White Diffuser	MC30 + \$195 Monster Cable 30 meter	RV + \$100 RVLDM Driver
P + \$50 Polarizer	MCHF4 + \$75 Monster High Flex Cable 4 meter	
	MCHF8 + \$100 Monster High Flex Cable 8 meter	
	MCHF15 + \$200 Monster High Flex Cable 15 meter	
	MCHF30 + \$380 Monster High Flex Cable 30 meter	

SD + \$0 Standard Diffuser	MC4 + \$0 Monster Cable 4 meter	LDM1400 + \$0 1400mA LED Driver DIN rail mount
CC + \$50 Clear Cover	MC8 + \$40 Monster Cable 8 meter	A + \$85 ALDM Driver
TFD + \$50 Thin Film Diffuser	MC15 + \$60 Monster Cable 15 meter	V + \$85 VLDM Driver
WD + \$50 White Diffuser	MC30 + \$195 Monster Cable 30 meter	RV + \$100 RVLDM Driver
P + \$75 Polarizer	MCHF4 + \$75 Monster High Flex Cable 4 meter	
	MCHF8 + \$100 Monster High Flex Cable 8 meter	
	MCHF15 + \$200 Monster High Flex Cable 15 meter	
	MCHF30 + \$380 Monster High Flex Cable 30 meter	

Back Lights
Diffused Axial
Dome Lights
Linear Lights
Oxy Lights
Ring Lights
Spot Lights
TriPod Lights
Washdown Lights
Controllers & Cables

Back Lights
Diffused Axial
Dome Lights
Linear Lights
Oxy Lights
Ring Lights
Spot Lights
TriPod Lights
Washdown Lights
Controllers & Cables

Monster-Series Linear Lights



Features:

- External driver/controller included
- High speed Strobe Technology
- High Power LED's (24 VDC)
- DIN rail mount driver/controller
- M12 connector for quick disconnect
- Available in 8 colors, Ultra-Violet, Infrared
- Available in 14 sizes
- 10 Year Warranty* - 100,000 hours

Caution –

The supplied LDM adapter must be used for both continuous or strobe operations! Do not connect the fixture directly to 24VDC! Operating the fixture without the supplied LDM adapter will result in premature LED failure and will void the warranty.

To Order, Specify;			
1 Base Part Number	Example:		
	MLL128.75	395	12
	\$1950	+ \$0	+ \$0
2 Specify LED Color	3 Specify Lens Type		

1 Base Part Number	List Price	2 Specify LED Color	3 Specify Lens Type		
MLL128.75 28.75" Linear Light LED's - Package Includes Light, LDM 1750, and 4 Meter Cable 	\$1950	365 + \$550 UV 365NM HB LED	12 + \$0 12 Degree Optics		
		395 + \$0 UV 395NM HB LED	16 + \$0 LED Optics 16 Frosted		
		470 + \$0 Blue	23 + \$0 LED Optics 23 Frosted		
		505 + \$0 Cyan	30 + \$0 30 Degree Frosted Optics		
		530 + \$0 Green	39 + \$0 LED Optics 39 Frosted		
		630 + \$0 Red	50 + \$0 50 Degree Optics		
		850 + \$0 Infrared	F + \$0 Wide Angle Optics		
		940 + \$0 Infrared	R + \$0 LED Reflector 90		
		WHI + \$0 White	R60 + \$0 LED Reflector 60		
		NWH + \$0 Natural White	L + \$0 LED Optics Line		
		WWH + \$0 Warm White			
		Standard Dimensions W 2.5" L 18.25" H 1.125"			
		MLL134.5 34.5" Linear Light LED's - Package Includes Light, LDM 2100, and 4 Meter Cable 			\$2250
		365 + \$650 UV 365NM HB LED 395 + \$0 UV 395NM HB LED 470 + \$0 Blue 505 + \$0 Cyan 530 + \$0 Green 630 + \$0 Red 850 + \$0 Infrared 940 + \$0 Infrared WHI + \$0 White NWH + \$0 Natural White WWH + \$0 Warm White			12 + \$0 12 Degree Optics 16 + \$0 LED Optics 16 Frosted 23 + \$0 LED Optics 23 Frosted 30 + \$0 30 Degree Frosted Optics 39 + \$0 LED Optics 39 Frosted 50 + \$0 50 Degree Optics F + \$0 Wide Angle Optics R + \$0 LED Reflector 90 R60 + \$0 LED Reflector 60 L + \$0 LED Optics Line
Standard Dimensions W 2.5" L 35.5" H 1.25" Wgt 5 lbs					

4 Specify Diffuser Option	5 Specify Cable Option	6 Specify Driver Option
SD + \$0 Standard Diffuser	MC4 + \$0 Monster Cable 4 meter	A + \$85 1750mA LED Driver DIN rail mount
CC + \$50 Clear Cover	MC8 + \$40 Monster Cable 8 meter	A + \$85 ALDM Driver
TFD + \$50 Thin Film Diffuser	MC15 + \$60 Monster Cable 15 meter	V + \$85 VLDM Driver
WD + \$50 White Diffuser	MC30 + \$195 Monster Cable 30 meter	RV + \$100 RVLDM Driver
P + \$100 Polarizer	MCHF4 + \$75 Monster High Flex Cable 4 meter	
	MCHF8 + \$100 Monster High Flex Cable 8 meter	
	MCHF15 + \$200 Monster High Flex Cable 15 meter	
	MCHF30 + \$380 Monster High Flex Cable 30 meter	

4 Specify Diffuser Option	5 Specify Cable Option	6 Specify Driver Option
SD + \$0 Standard Diffuser	MC4 + \$0 Monster Cable 4 meter	LDM1750 + \$0 1750mA LED Driver DIN rail mount
CC + \$50 Clear Cover	MC8 + \$40 Monster Cable 8 meter	A + \$85 ALDM Driver
TFD + \$50 Thin Film Diffuser	MC15 + \$60 Monster Cable 15 meter	V + \$85 VLDM Driver
WD + \$50 White Diffuser	MC30 + \$195 Monster Cable 30 meter	RV + \$100 RVLDM Driver
P + \$100 Polarizer	MCHF4 + \$75 Monster High Flex Cable 4 meter	
	MCHF8 + \$100 Monster High Flex Cable 8 meter	
	MCHF15 + \$200 Monster High Flex Cable 15 meter	
	MCHF30 + \$380 Monster High Flex Cable 30 meter	
SD + \$0 Standard Diffuser	MC4 + \$0 Monster Cable 4 meter	LDM2100 + \$0 2100mA LED Driver DIN rail mount
CC + \$50 Clear Cover	MC8 + \$40 Monster Cable 8 meter	A + \$85 ALDM Driver
TFD + \$50 Thin Film Diffuser	MC15 + \$60 Monster Cable 15 meter	V + \$85 VLDM Driver
WD + \$50 White Diffuser	MC30 + \$195 Monster Cable 30 meter	RV + \$100 RVLDM Driver
P + \$100 Polarizer	MCHF4 + \$75 Monster High Flex Cable 4 meter	
	MCHF8 + \$100 Monster High Flex Cable 8 meter	
	MCHF15 + \$200 Monster High Flex Cable 15 meter	
	MCHF30 + \$380 Monster High Flex Cable 30 meter	

Monster-Series Linear Lights

Features:



- External driver/controller included
- High speed Strobe Technology
- High Power LED's (24 VDC)
- DIN rail mount driver/controller
- M12 connector for quick disconnect
- Available in 8 colors, Ultra-Violet, Infrared
- Available in 14 sizes
- 10 Year Warranty* - 100,000 hours

Caution –

The supplied LDM adapter must be used for both continuous or strobe operations! Do not connect the fixture directly to 24VDC! Operating the fixture without the supplied LDM adapter will result in premature LED failure and will void the warranty.

To Order, Specify;

1 Base Part Number	Example:	HLL111.5	470	12
		\$1000	+ \$0	+ \$0
2 Specify LED Color			3 Specify Lens Type	

1 Base Part Number	List Price	2 Specify LED Color	3 Specify Lens Type		
HLL111.5 11.5" Linear Light LED with Extrusion Housing - Package includes light, LDM 700, and 4 meter cable 	\$1000	365 + \$250 UV 365NM HB LED	12 + \$0 12 Degree Optics		
		395 + \$0 UV 395NM HB LED	16 + \$0 LED Optics 16 Frosted		
		470 + \$0 Blue	23 + \$0 LED Optics 23 Frosted		
		505 + \$0 Cyan	30 + \$0 30 Degree Frosted Optics		
		530 + \$0 Green	39 + \$0 LED Optics 39 Frosted		
		590 + \$0 Amber	50 + \$0 50 Degree Optics		
		630 + \$0 Red	F + \$0 Wide Angle Optics		
		850 + \$0 Infrared	R + \$0 LED Reflector 90		
		WHI + \$0 White	R60 + \$0 LED Reflector 60		
		NWH + \$0 Natural White	L + \$0 LED Optics Line		
		WWH + \$0 Warm White			
		HLL123 23" Linear Light LED with Extrusion Housing - Package includes light, LDM 1400, and 4 meter cable 	\$1600	365 + \$450 UV 365NM HB LED	12 + \$0 12 Degree Optics
				395 + \$0 UV 395NM HB LED	16 + \$0 LED Optics 16 Frosted
				470 + \$0 Blue	23 + \$0 LED Optics 23 Frosted
505 + \$0 Cyan	30 + \$0 30 Degree Frosted Optics				
530 + \$0 Green	39 + \$0 LED Optics 39 Frosted				
590 + \$0 Amber	50 + \$0 50 Degree Optics				
630 + \$0 Red	F + \$0 Wide Angle Optics				
850 + \$0 Infrared	R + \$0 LED Reflector 90				
WHI + \$0 White	R60 + \$0 LED Reflector 60				
NWH + \$0 Natural White	L + \$0 LED Optics Line				
WWH + \$0 Warm White					

4 Specify Diffuser Option **5** Specify Cable Option **6** Specify Driver Option

SD + \$0	MC4 + \$0	A + \$85
---------------------------	----------------------------	---------------------------

4 Specify Diffuser Option	5 Specify Cable Option	6 Specify Driver Option
SD + \$0 Standard Diffuser	MC4 + \$0 Monster Cable 4 meter	LDM700 + \$0 700mA LED Driver DIN Rail Mount
CC + \$25 Clear Cover	MC8 + \$40 Monster Cable 8 meter	A + \$85 ALDM Driver
TFD + \$25 Thin Film Diffuser	MC15 + \$60 Monster Cable 15 meter	V + \$85 VLDM Driver
WD + \$25 White Diffuser	MC30 + \$195 Monster Cable 30 meter	RV + \$100 RVLDM Driver
P + \$50 Polarizer	MCHF4 + \$75 Monster High Flex Cable 4 meter	
	MCHF8 + \$100 Monster High Flex Cable 8 meter	
	MCHF15 + \$200 Monster High Flex Cable 15 meter	
	MCHF30 + \$380 Monster High Flex Cable 30 meter	
SD + \$0 Standard Diffuser	MC4 + \$0 Monster Cable 4 meter	LDM1400 + \$0 1400mA LED Driver DIN rail mount
CC + \$50 Clear Cover	MC8 + \$40 Monster Cable 8 meter	A + \$85 ALDM Driver
TFD + \$50 Thin Film Diffuser	MC15 + \$60 Monster Cable 15 meter	V + \$85 VLDM Driver
WD + \$50 White Diffuser	MC30 + \$195 Monster Cable 30 meter	RV + \$100 RVLDM Driver
P + \$75 Polarizer	MCHF4 + \$75 Monster High Flex Cable 4 meter	
	MCHF8 + \$100 Monster High Flex Cable 8 meter	
	MCHF15 + \$200 Monster High Flex Cable 15 meter	
	MCHF30 + \$380 Monster High Flex Cable 30 meter	

Monster-Series Linear Lights

Features:

- External driver/controller included
- High speed Strobe Technology
- High Power LED's (24 VDC)
- DIN rail mount driver/controller
- M12 connector for quick disconnect
- Available in 8 colors, Ultra-Violet, Infrared
- Available in 14 sizes
- 10 Year Warranty* - 100,000 hours

Caution –

The supplied LDM adapter must be used for both continuous or strobe operations! Do not connect the fixture directly to 24VDC! Operating the fixture without the supplied LDM adapter will result in premature LED failure and will void the warranty.

To Order, Specify;			
1 Base Part Number			
Example:	HLL134.5	470	12
	\$2250	+ \$0	+ \$0
2 Specify LED Color		3 Specify Lens Type	

1 Base Part Number	List Price	2 Specify LED Color	3 Specify Lens Type
HLL134.5 34.5" Linear Light LED with Extrusion Housing - Package includes light, LDM 2100, and 4 meter cable	\$2250	365 + \$650 UV 365NM HB LED	12 + \$0 12 Degree Optics
		395 + \$0 UV 395NM HB LED	16 + \$0 LED Optics 16 Frosted
		470 + \$0 Blue	23 + \$0 LED Optics 23 Frosted
		505 + \$0 Cyan	30 + \$0 30 Degree Frosted Optics
		530 + \$0 Green	39 + \$0 LED Optics 39 Frosted
		590 + \$0 Amber	50 + \$0 50 Degree Optics
Standard Dimensions		630 + \$0 Red	F + \$0 Wide Angle Optics
W 2.5"		850 + \$0 Infrared	R + \$0 LED Reflector 90
L 35.5"		WHI + \$0 White	R60 + \$0 LED Reflector 60
H 1.355"		NWH + \$0 Natural White	L + \$0 LED Optics Line
		WWH + \$0 Warm White	

4 Specify Diffuser Option	5 Specify Cable Option	6 Specify Driver Option
SD + \$0	MC4 + \$0	A + \$85

4 Specify Diffuser Option	5 Specify Cable Option	6 Specify Driver Option
SD + \$0 Standard Diffuser	MC4 + \$0 Monster Cable 4 meter	LDM2100 + \$0 2100mA LED Driver DIN rail mount
CC + \$50 Clear Cover	MC8 + \$40 Monster Cable 8 meter	A + \$85 ALDM Driver
TFD + \$50 Thin Film Diffuser	MC15 + \$60 Monster Cable 15 meter	V + \$85 VLDM Driver
WD + \$50 White Diffuser	MC30 + \$195 Monster Cable 30 meter	RV + \$100 RVLDM Driver
P + \$100 Polarizer	MCHF4 + \$75 Monster High Flex Cable 4 meter	
	MCHF8 + \$100 Monster High Flex Cable 8 meter	
	MCHF15 + \$200 Monster High Flex Cable 15 meter	
	MCHF30 + \$380 Monster High Flex Cable 30 meter	

Monster-Series Linear Lights

Features:



- External driver/controller included
- High speed Strobe Technology
- High Power LED's (24 VDC)
- DIN rail mount driver/controller
- M12 connector for quick disconnect
- Available in 8 colors, Ultra-Violet, Infrared
- Available in 14 sizes
- 10 Year Warranty* - 100,000 hours

Caution –

The supplied LDM adapter must be used for both continuous or strobe operations! Do not connect the fixture directly to 24VDC! Operating the fixture without the supplied LDM adapter will result in premature LED failure and will void the warranty.

To Order, Specify;

1 Base Part Number	Example:	MLL146	395	12
		\$3150	+ \$0	+ \$0
2 Specify LED Color			3 Specify Lens Type	

1 Base Part Number	List Price	2 Specify LED Color	3 Specify Lens Type
MLL146 46" Linear Light LED's - Package Includes Light, LDM 2800, and 4 Meter Cable  Standard Dimensions W 3.8" L 49.25" H 3.5" Wgt 14.2 lbs	\$3150	365 + \$850 UV 365NM HB LED 395 + \$0 UV 395NM HB LED 470 + \$0 Blue 505 + \$0 Cyan 530 + \$0 Green 630 + \$0 Red 850 + \$0 Infrared 940 + \$0 Infrared WHI + \$0 White NWH + \$0 Natural White WWH + \$0 Warm White	12 + \$0 12 Degree Optics 16 + \$0 LED Optics 16 Frosted 23 + \$0 LED Optics 23 Frosted 30 + \$0 30 Degree Frosted Optics 39 + \$0 LED Optics 39 Frosted 50 + \$0 50 Degree Optics F + \$0 Wide Angle Optics R + \$0 LED Reflector 90 R60 + \$0 LED Reflector 60 L + \$0 LED Optics Line
MLL157.5 57.5" Linear Light LED's - Package Includes Light, LDM 3500, and 4 Meter Cable  Standard Dimensions W 3.8" L 60.75" H 3.5" Wgt 17.35 lbs	\$4250	365 + \$1000 UV 365NM HB LED 395 + \$0 UV 395NM HB LED 470 + \$0 Blue 505 + \$0 Cyan 530 + \$0 Green 630 + \$0 Red 850 + \$0 Infrared 940 + \$0 Infrared WHI + \$0 White NWH + \$0 Natural White WWH + \$0 Warm White	12 + \$0 12 Degree Optics 16 + \$0 LED Optics 16 Frosted 23 + \$0 LED Optics 23 Frosted 30 + \$0 30 Degree Frosted Optics 39 + \$0 LED Optics 39 Frosted 50 + \$0 50 Degree Optics F + \$0 Wide Angle Optics R + \$0 LED Reflector 90 R60 + \$0 LED Reflector 60 L + \$0 LED Optics Line

4 Specify Diffuser Option **5** Specify Cable Option **6** Specify Driver Option

SD + \$0	MC4 + \$0	A + \$85
---------------------------	----------------------------	---------------------------

4 Specify Diffuser Option	5 Specify Cable Option	6 Specify Driver Option
SD + \$0 Standard Diffuser CC + \$75 Clear Cover TFD + \$75 Thin Film Diffuser WD + \$75 White Diffuser P + \$125 Polarizer	MC4 + \$0 Monster Cable 4 meter MC8 + \$40 Monster Cable 8 meter MC15 + \$60 Monster Cable 15 meter MC30 + \$195 Monster Cable 30 meter MCHF4 + \$75 Monster High Flex Cable 4 meter MCHF8 + \$100 Monster High Flex Cable 8 meter MCHF15 + \$200 Monster High Flex Cable 15 meter MCHF30 + \$380 Monster High Flex Cable 30 meter	LDM2800 + \$0 2800mA LED Driver DIN rail mount A + \$85 ALDM Driver V + \$85 VLDM Driver RV + \$100 RVLDM Driver LDM3500 + \$0 3500mA LED Driver DIN rail mount A + \$85 ALDM Driver V + \$85 VLDM Driver RV + \$100 RVLDM Driver

Back Lights
Diffused Axial
Dome Lights
Linear Lights
Oxy Lights
Ring Lights
Spot Lights
TriPod Lights
Washdown Lights
Controllers & Cables

Back Lights
Diffused Axial
Dome Lights
Linear Lights
Oxy Lights
Ring Lights
Spot Lights
TriPod Lights
Washdown Lights
Controllers & Cables

Monster-Series Linear Lights



Features:

- External driver/controller included
- High speed Strobe Technology
- High Power LED's (24 VDC)
- DIN rail mount driver/controller
- M12 connector for quick disconnect
- Available in 8 colors, Ultra-Violet, Infrared
- Available in 14 sizes
- 10 Year Warranty* - 100,000 hours

Caution –

The supplied LDM adapter must be used for both continuous or strobe operations! Do not connect the fixture directly to 24VDC! Operating the fixture without the supplied LDM adapter will result in premature LED failure and will void the warranty.

To Order, Specify;			
1 Base Part Number			
Example:	MLL169	470	12
	\$5350	+ \$0	+ \$0
2 Specify LED Color		3 Specify Lens Type	

1 Base Part Number	List Price	2 Specify LED Color	3 Specify Lens Type		
MLL169 69" Linear Light LED's - Package Includes Light, LDM 4200, and 4 Meter Cable  Standard Dimensions W 3.8" L 72.25" H 3.5" Wgt 17.35 lbs	\$5350	365 + \$1200 UV 365NM HB LED	12 + \$0 12 Degree Optics		
		395 + \$0 UV 395NM HB LED	16 + \$0 LED Optics 16 Frosted		
		470 + \$0 Blue	23 + \$0 LED Optics 23 Frosted		
		505 + \$0 Cyan	30 + \$0 30 Degree Frosted Optics		
		530 + \$0 Green	39 + \$0 LED Optics 39 Frosted		
		630 + \$0 Red	50 + \$0 50 Degree Optics		
		850 + \$0 Infrared	F + \$0 Wide Angle Optics		
		940 + \$0 Infrared	R + \$0 LED Reflector 90		
		WHI + \$0 White	R60 + \$0 LED Reflector 60		
		NWH + \$0 Natural White	L + \$0 LED Optics Line		
		WWH + \$0 Warm White			
		MLL180.5 80.5" Linear Light LED - Package Includes Light, LDM 4900, and 4 Meter Cable  Standard Dimensions W 3.8" L 83.75" H 3.5"	\$5450	365 + \$1400 UV 365NM HB LED	12 + \$0 12 Degree Optics
				395 + \$0 UV 395NM HB LED	16 + \$0 LED Optics 16 Frosted
				470 + \$0 Blue	23 + \$0 LED Optics 23 Frosted
505 + \$0 Cyan	30 + \$0 30 Degree Frosted Optics				
530 + \$0 Green	39 + \$0 LED Optics 39 Frosted				
630 + \$0 Red	50 + \$0 50 Degree Optics				
850 + \$0 Infrared	F + \$0 Wide Angle Optics				
940 + \$0 Infrared	R + \$0 LED Reflector 90				
WHI + \$0 White	R60 + \$0 LED Reflector 60				
NWH + \$0 Natural White	L + \$0 LED Optics Line				
WWH + \$0 Warm White					

4 Specify Diffuser Option	5 Specify Cable Option	6 Specify Driver Option
SD + \$0 Standard Diffuser	MC4 + \$0 Monster Cable High Output 4 meter	A + \$85 4200mA LED Driver DIN rail mount
CC + \$125 Clear Cover	MC8-HO/6 + \$150 Monster Cable High Output 8 meter	A + \$85 ALDM Driver
WD + \$125 White Diffuser	MC15-HO/6+ \$200 Monster Cable High Output 15 meter	V + \$85 VLDM Driver
	MC30-HO/6 * Monster Cable High Output 15 meter	RV + \$100 RVLDM Driver

4 Specify Diffuser Option	5 Specify Cable Option	6 Specify Driver Option
SD + \$0 Standard Diffuser	MC4-HO/6 + \$0 Monster Cable High Output 4 meter	LDM4200 + \$0 4200mA LED Driver DIN rail mount
CC + \$125 Clear Cover	MC8-HO/6 + \$150 Monster Cable High Output 8 meter	A + \$85 ALDM Driver
WD + \$125 White Diffuser	MC15-HO/6+ \$200 Monster Cable High Output 15 meter	V + \$85 VLDM Driver
	MC30-HO/6 * Monster Cable High Output 15 meter	RV + \$100 RVLDM Driver
	MCHF4-HO/6 * Monster High Flex High Output 4 meter cable	
	MCHF8-HO/6 * Monster High Flex High Output 8 meter cable	
	MCHF15-HO/6 * Monster High Flex High Output 15 meter cable	
	MCHF30-HO/6 * Monster High Flex High Output 30 meter cable	

*Call for pricing

SD + \$0 Standard Diffuser	MC4-HO/6 + \$0 Monster Cable High Output 4 meter	LDM4900 + \$0 4900 mA LED Driver DIN Rail Mount
CC + \$150 Clear Cover	MC8-HO/6 + \$150 Monster Cable High Output 8 meter	A + \$85 ALDM Driver
WD + \$150 White Diffuser	MC15-HO/6+ \$200 Monster Cable High Output 15 meter	V + \$85 VLDM Driver
	MC30-HO/6 * Monster Cable High Output 15 meter	RV + \$100 RVLDM Driver
	MCHF4-HO/6 * Monster High Flex High Output 4 meter cable	
	MCHF8-HO/6 * Monster High Flex High Output 8 meter cable	
	MCHF15-HO/6 * Monster High Flex High Output 15 meter cable	
	MCHF30-HO/6 * Monster High Flex High Output 30 meter cable	

*Call for pricing

Monster-Series Linear Lights



Features:

- External driver/controller included
- High speed Strobe Technology
- High Power LED's (24 VDC)
- DIN rail mount driver/controller
- M12 connector for quick disconnect
- Available in 8 colors, Ultra-Violet, Infrared
- Available in 14 sizes
- 10 Year Warranty* - 100,000 hours

Caution –

The supplied LDM adapter must be used for both continuous or strobe operations! Do not connect the fixture directly to 24VDC! Operating the fixture without the supplied LDM adapter will result in premature LED failure and will void the warranty.

To Order, Specify;			
1 Base Part Number			
Example:	MLL22	365	12
	\$500	+ \$50	+ \$0
2 Specify LED Color		3 Specify Lens Type	

1 Base Part Number	List Price	2 Specify LED Color	3 Specify Lens Type		
MLL22 2" X 2" Linear Light LED - Package Includes Light, LDM 700, and 4 Meter Cable  <p>Standard Dimensions</p> <p>W 3" L 3" H 1.125"</p>	\$500	365 + \$50 UV 365NM HB LED	12 + \$0 12 Degree Optics		
		395 + \$0 UV 395NM HB LED	16 + \$0 LED Optics 16 Frosted		
		470 + \$0 Blue	23 + \$0 LED Optics 23 Frosted		
		505 + \$0 Cyan	30 + \$0 30 Degree Frosted Optics		
		530 + \$0 Green	39 + \$0 LED Optics 39 Frosted		
		590 + \$0 Amber	50 + \$0 50 Degree Optics		
		630 + \$0 Red	F + \$0 Wide Angle Optics		
		850 + \$0 Infrared	R + \$0 LED Reflector 90		
		940 + \$0 Infrared	R60 + \$0 LED Reflector 60		
		WHI + \$0 White	L + \$0 LED Optics Line		
		NWH + \$0 Natural White			
		WWH + \$0 Warm White			
		MLL24 2" x 4" Linear Light LED - Package Includes Light, LDM 700, and 4 Meter Cable  <p>Standard Dimensions</p> <p>W 3" L 5" H 1"</p>	\$725	365 + \$100 UV 365NM HB LED	12 + \$0 12 Degree Optics
				395 + \$0 UV 395NM HB LED	16 + \$0 LED Optics 16 Frosted
470 + \$0 Blue	23 + \$0 LED Optics 23 Frosted				
505 + \$0 Cyan	30 + \$0 30 Degree Frosted Optics				
530 + \$0 Green	39 + \$0 LED Optics 39 Frosted				
590 + \$0 Amber	50 + \$0 50 Degree Optics				
630 + \$0 Red	F + \$0 Wide Angle Optics				
850 + \$0 Infrared	R + \$0 LED Reflector 90				
940 + \$0 Infrared	R60 + \$0 LED Reflector 60				
WHI + \$0 White	L + \$0 LED Optics Line				
NWH + \$0 Natural White					
WWH + \$0 Warm White					

4 Specify Diffuser Option	5 Specify Cable Option	6 Specify Driver Option
SD + \$0	MC4 + \$0	A + \$85

4 Specify Diffuser Option	5 Specify Cable Option	6 Specify Driver Option
SD + \$0 Standard Diffuser	MC4 + \$0 Monster Cable 4 meter	LDM700 + \$0 700mA LED Driver DIN Rail Mount
CC + \$25 Clear Cover	MC8 + \$40 Monster Cable 8 meter	A + \$85 ALDM Driver
TFD + \$25 Thin Film Diffuser	MC15 + \$60 Monster Cable 15 meter	V + \$85 VLDM Driver
WD + \$25 White Diffuser	MC30 + \$195 Monster Cable 30 meter	RV + \$100 RVLDM Driver
P + \$25 Polarizer	MCHF4 + \$75 Monster High Flex Cable 4 meter	
	MCHF8 + \$100 Monster High Flex Cable 8 meter	
	MCHF15 + \$200 Monster High Flex Cable 15 meter	
	MCHF30 + \$380 Monster High Flex Cable 30 meter	
SD + \$0 Standard Diffuser	MC4 + \$0 Monster Cable 4 meter	LDM700 + \$0 700mA LED Driver DIN Rail Mount
CC + \$25 Clear Cover	MC8 + \$40 Monster Cable 8 meter	A + \$85 ALDM Driver
TFD + \$25 Thin Film Diffuser	MC15 + \$60 Monster Cable 15 meter	V + \$85 VLDM Driver
WD + \$25 White Diffuser	MC30 + \$195 Monster Cable 30 meter	RV + \$100 RVLDM Driver
P + \$25 Polarizer	MCHF4 + \$75 Monster High Flex Cable 4 meter	
	MCHF8 + \$100 Monster High Flex Cable 8 meter	
	MCHF15 + \$200 Monster High Flex Cable 15 meter	
	MCHF30 + \$380 Monster High Flex Cable 30 meter	

Monster-Series Linear Lights



Features:

- External driver/controller included
- High speed Strobe Technology
- High Power LED's (24 VDC)
- DIN rail mount driver/controller
- M12 connector for quick disconnect
- Available in 8 colors, Ultra-Violet, Infrared
- Available in 14 sizes
- 10 Year Warranty* - 100,000 hours

Caution –

The supplied LDM adapter must be used for both continuous or strobe operations! Do not connect the fixture directly to 24VDC! Operating the fixture without the supplied LDM adapter will result in premature LED failure and will void the warranty.

To Order, Specify;			
1 Base Part Number			
Example:	MLL26	395	12
	\$1000	+ \$0	+ \$0
2 Specify LED Color		3 Specify Lens Type	

1 Base Part Number	List Price	2 Specify LED Color	3 Specify Lens Type
MLL26 2" X 6" Linear Light LED's - Package Includes Light, LDM 700, and 4 Meter Cable	\$1000	365 + \$150 UV 365NM HB LED 395 + \$0 UV 395NM HB LED 470 + \$0 Blue 505 + \$0 Cyan 530 + \$0 Green 590 + \$0 Amber 630 + \$0 Red 850 + \$0 Infrared WHI + \$0 White NWH + \$0 Natural White WWH + \$0 Warm White	12 + \$0 12 Degree Optics 16 + \$0 LED Optics 16 Frosted 23 + \$0 LED Optics 23 Frosted 30 + \$0 30 Degree Frosted Optics 39 + \$0 LED Optics 39 Frosted 50 + \$0 50 Degree Optics F + \$0 Wide Angle Optics R + \$0 LED Reflector 90 R60 + \$0 LED Reflector 60 L + \$0 LED Optics Line
 Standard Dimensions W 3.25" L 7.25" H 1.125" Wgt 1.25 lbs			
MLL44 4" x 4" Linear Light LED - Package Includes Light, LDM 1400, and 4 Meter Cable	\$1025	365 + \$200 UV 365NM HB LED 395 + \$0 UV 395NM HB LED 470 + \$0 Blue 505 + \$0 Cyan 530 + \$0 Green 590 + \$0 Amber 630 + \$0 Red 850 + \$0 Infrared 940 + \$0 Infrared WHI + \$0 White NWH + \$0 Natural White WWH + \$0 Warm White	12 + \$0 12 Degree Optics 16 + \$0 LED Optics 16 Frosted 23 + \$0 LED Optics 23 Frosted 30 + \$0 30 Degree Frosted Optics 39 + \$0 LED Optics 39 Frosted 50 + \$0 50 Degree Optics F + \$0 Wide Angle Optics R + \$0 LED Reflector 90 R60 + \$0 LED Reflector 60 L + \$0 LED Optics Line
 Standard Dimensions W 5" L 5" H 1"			

4 Specify Diffuser Option	5 Specify Cable Option	6 Specify Driver Option
SD + \$0	MC4 + \$0	A + \$85

4 Specify Diffuser Option	5 Specify Cable Option	6 Specify Driver Option
SD + \$0 Standard Diffuser CC + \$25 Clear Cover TFD + \$25 Thin Film Diffuser WD + \$25 White Diffuser P + \$25 Polarizer	MC4 + \$0 Monster Cable 4 meter MC8 + \$40 Monster Cable 8 meter MC15 + \$60 Monster Cable 15 meter MC30 + \$195 Monster Cable 30 meter MCHF4 + \$75 Monster High Flex Cable 4 meter MCHF8 + \$100 Monster High Flex Cable 8 meter MCHF15 + \$200 Monster High Flex Cable 15 meter MCHF30 + \$380 Monster High Flex Cable 30 meter	LDM700 + \$0 700mA LED Driver DIN Rail Mount A + \$85 ALDM Driver V + \$85 VLDM Driver RV + \$100 RVLDM Driver

SD + \$0 Standard Diffuser CC + \$25 Clear Cover TFD + \$25 Thin Film Diffuser WD + \$25 White Diffuser P + \$25 Polarizer	MC4 + \$0 Monster Cable 4 meter MC8 + \$40 Monster Cable 8 meter MC15 + \$60 Monster Cable 15 meter MC30 + \$195 Monster Cable 30 meter MCHF4 + \$75 Monster High Flex Cable 4 meter MCHF8 + \$100 Monster High Flex Cable 8 meter MCHF15 + \$200 Monster High Flex Cable 15 meter MCHF30 + \$380 Monster High Flex Cable 30 meter	LDM1400 + \$0 1400mA LED Driver DIN Rail Mount A + \$85 ALDM Driver V + \$85 VLDM Driver RV + \$100 RVLDM Driver
--	---	---

Monster-Series Linear Lights



Features:

- External driver/controller included
- High speed Strobe Technology
- High Power LED's (24 VDC)
- DIN rail mount driver/controller
- M12 connector for quick disconnect
- Available in 8 colors, Ultra-Violet, Infrared
- Available in 14 sizes
- 10 Year Warranty* - 100,000 hours

Caution –

The supplied LDM adapter must be used for both continuous or strobe operations! Do not connect the fixture directly to 24VDC! Operating the fixture without the supplied LDM adapter will result in premature LED failure and will void the warranty.

To Order, Specify;			
1 Base Part Number			
Example:	MLL46	365	12
	\$1450	+ \$230	+ \$0
2 Specify LED Color		3 Specify Lens Type	

1 Base Part Number	List Price	2 Specify LED Color	3 Specify Lens Type		
MLL46 4" x 6" Linear Light LED – Package Includes Light, LDM 2100, and 4 Meter Cable 	\$1450	365 + \$300 UV 365NM HB LED	12 + \$0 12 Degree Optics		
		395 + \$0 UV 395NM HB LED	16 + \$0 LED Optics 16 Frosted		
		470 + \$0 Blue	23 + \$0 LED Optics 23 Frosted		
		505 + \$0 Cyan	30 + \$0 30 Degree Frosted Optics		
		530 + \$0 Green	39 + \$0 LED Optics 39 Frosted		
		590 + \$0 Amber	50 + \$0 50 Degree Optics		
		630 + \$0 Red	F + \$0 Wide Angle Optics		
		850 + \$0 Infrared	R + \$0 LED Reflector 90		
		940 + \$0 Infrared	R60 + \$0 LED Reflector 60		
		WHI + \$0 White	L + \$0 LED Optics Line		
		NWH + \$0 Natural White			
		WWH + \$0 Warm White			
		MLL48 4" x 8" Linear Light LED – Package Includes Light, LDM 2800, and 4 Meter Cable 	\$1950	365 + \$400 UV 365NM HB LED	12 + \$0 12 Degree Optics
				395 + \$0 UV 395NM HB LED	16 + \$0 LED Optics 16 Frosted
470 + \$0 Blue	23 + \$0 LED Optics 23 Frosted				
505 + \$0 Cyan	30 + \$0 30 Degree Frosted Optics				
530 + \$0 Green	39 + \$0 LED Optics 39 Frosted				
590 + \$0 Amber	50 + \$0 50 Degree Optics				
630 + \$0 Red	F + \$0 Wide Angle Optics				
850 + \$0 Infrared	R + \$0 LED Reflector 90				
940 + \$0 Infrared	R60 + \$0 LED Reflector 60				
WHI + \$0 White	L + \$0 LED Optics Line				
NWH + \$0 Natural White					
WWH + \$0 Warm White					

4 Specify Diffuser Option	5 Specify Cable Option	6 Specify Driver Option
SD + \$0	MC4 + \$0	A + \$85

4 Specify Diffuser Option	5 Specify Cable Option	6 Specify Driver Option
SD + \$0 Standard Diffuser	MC4 + \$0 Monster Cable 4 meter	LDM2100 + \$0 2100mA LED Driver DIN Rail Mount
CC + \$25 Clear Cover	MC8 + \$40 Monster Cable 8 meter	A + \$85 ALDM Driver
TFD + \$25 Thin Film Diffuser	MC15 + \$60 Monster Cable 15 meter	V + \$85 VLDM Driver
WD + \$25 White Diffuser	MC30 + \$195 Monster Cable 30 meter	RV + \$100 RVLDM Driver
P + \$25 Polarizer	MCHF4 + \$75 Monster High Flex Cable 4 meter	
	MCHF8 + \$100 Monster High Flex Cable 8 meter	
	MCHF15 + \$200 Monster High Flex Cable 15 meter	
	MCHF30 + \$380 Monster High Flex Cable 30 meter	

SD + \$0 Standard Diffuser	MC4 + \$0 Monster Cable 4 meter	LDM2800 + \$0 2800mA LED Driver DIN Rail Mount
CC + \$25 Clear Cover	MC8 + \$40 Monster Cable 8 meter	A + \$85 ALDM Driver
TFD + \$25 Thin Film Diffuser	MC15 + \$60 Monster Cable 15 meter	V + \$85 VLDM Driver
WD + \$25 White Diffuser	MC30 + \$195 Monster Cable 30 meter	RV + \$100 RVLDM Driver
P + \$25 Polarizer	MCHF4 + \$75 Monster High Flex Cable 4 meter	
	MCHF8 + \$100 Monster High Flex Cable 8 meter	
	MCHF15 + \$200 Monster High Flex Cable 15 meter	
	MCHF30 + \$380 Monster High Flex Cable 30 meter	

This page is intentionally blank



MACHINE VISION LIGHTING SINCE 1999



Monster-Series (Internal Driver Linear “Bright Field” Lights)

Spectrum Illumination’s Monster-Series Linear “Bright Field” Lights are designed to provide high-intensity illumination of large areas, at long distances.



Units come with light and cable.

Series Highlights

- Internal Driver Built-in/controller included
- Auto Burst Technology
- High Power LED’s (24 VDC)
- M12 connector for quick disconnect
- Available in 8 colors, Ultra-Violet & Infrared
- Available in 4 sizes - 6", 11.5", 17.25" & 23"
- 0 - 10 VDC intensity Control
- Potentiometer Intensity Control
- 10 Year Warranty* - 100,000 hours

Application Examples

- Food and Beverage
- High speed bottling and canning operations
- Inspection
- Measure translucency
- Pharmaceutical
- Robotic Applications

Units come with light, driver(s) / controller(s) and cable.

- *10-Year warranty on registered products
- *6-Year warranty on non-registered products
- *3-year warranty on washdown lights
- spectrumillumination/limited-warranty/

P: (231) 894-4590
E: sales@spectrumillumination.com

SpectrumIllumination.com



Monster-Series Linear Lights with Internal Driver

Features:

- Internal Driver Built-in/controller included
- Auto Burst Technology
- High Power LED's (24 VDC)
- M12 connector for quick disconnect
- Available in 8 colors, Ultra-Violet, and Infrared
- Available in 4 sizes
- 0 - 10 VDC intensity Control
- Potentiometer Intensity Control
- 10 Year Warranty* - 100,000 hours

To Order, Specify;	
1 Base Part Number	
Example:	MLLD16
	\$500
2 Specify LED Color	470
	+ \$0



1 Base Part Number	List Price	2 Specify LED Color
MLLD16 6" Linear Light LED - Package Includes Light and 3 Meter Cable	\$500	365 + \$150 UV 365NM HB LED 395 + \$0 UV 395NM HB LED 470 + \$0 Blue 505 + \$0 Cyan 530 + \$0 Green 630 + \$0 Red 850 + \$0 Infrared 940 + \$0 Infrared WHI + \$0 White NWH + \$0 Natural White WWH + \$0 Warm White
 Standard Dimensions W 2.25" L 6.50" H 1.125" Wgt .8 lbs		
MLLD111.5 11.5" Linear Light LED - Package Includes Light and 3 Meter Cable	\$950	365 + \$250 UV 365NM HB LED 395 + \$0 UV 395NM HB LED 470 + \$0 Blue 505 + \$0 Cyan 530 + \$0 Green 630 + \$0 Red 850 + \$0 Infrared 940 + \$0 Infrared WHI + \$0 White NWH + \$0 Natural White WWH + \$0 Warm White
 Standard Dimensions W 2.5" L 13.0 H 1.125" Wgt 1.45 lbs		

3 Specify Lens Type	4 Specify Diffuser Option	5 Specify Cable Option
16 + \$0	SD + \$0	EC3 + \$0

3 Specify Lens Type	4 Specify Diffuser Option	5 Specify Cable Option
12 + \$0 12 Degree Optics 16 + \$0 LED Optics 16 Frosted 23 + \$0 LED Optics 23 Frosted 30 + \$0 30 Degree Frosted Optics 39 + \$0 LED Optics 39 Frosted 50 + \$0 50 Degree Optics F + \$0 Wide Angle Optics R + \$0 LED Reflector 90 R60 + \$0 LED Reflector 60 L + \$0 LED Optics Line	SD + \$0 Standard Diffuser CC + \$25 Clear Cover TFD + \$25 Thin Film Diffuser WD + \$25 White Diffuser P + \$25 Polarizer	EC3 + \$0 E-Series Cable 3M EC5 + \$15 E-Series Cable 5M
12 + \$0 12 Degree Optics 16 + \$0 LED Optics 16 Frosted 23 + \$0 LED Optics 23 Frosted 30 + \$0 30 Degree Frosted Optics 39 + \$0 LED Optics 39 Frosted 50 + \$0 50 Degree Optics F + \$0 Wide Angle Optics R + \$0 LED Reflector 90 R60 + \$0 LED Reflector 60 L + \$0 LED Optics Line	SD + \$0 Standard Diffuser CC + \$25 Clear Cover TFD + \$25 Thin Film Diffuser WD + \$25 White Diffuser P + \$25 Polarizer	EC3 + \$0 E-Series Cable 3M EC5 + \$15 E-Series Cable 5M

Monster-Series Linear Lights with Internal Driver

Features:

- Internal Driver Built-in/controller included
- Auto Burst Technology
- High Power LED's (24 VDC)
- M12 connector for quick disconnect
- Available in 8 colors, Ultra-Violet, and Infrared
- Available in 4 sizes
- 0 - 10 VDC intensity Control
- Potentiometer Intensity Control
- 10 Year Warranty* - 100,000 hours



To Order, Specify;

1 Base Part Number

Example: **MLLD117.25**
\$1200

2 Specify LED Color **470**
+ \$0



1 Base Part Number	List Price	2 Specify LED Color
MLLD117.25 17.25" Linear Light LED - Package Includes Light and 3 Meter Cable	\$1200	365 + \$350 UV 365NM HB LED 395 + \$0 UV 395NM HB LED 470 + \$0 Blue 505 + \$0 Cyan 530 + \$0 Green 630 + \$0 Red 850 + \$0 Infrared 940 + \$0 Infrared WHI + \$0 White NWH + \$0 Natural White WWH + \$0 Warm White
		
Standard Dimensions		
W 2.5"		
L 18.50"		
H 1.125"		
Wgt 2.6 lbs		
MLLD123 11.5" Linear Light LED - Package Includes Light and 3 Meter Cable	\$1525	365 + \$450 UV 365NM HB LED 395 + \$0 UV 395NM HB LED 470 + \$0 Blue 505 + \$0 Cyan 530 + \$0 Green 630 + \$0 Red 850 + \$0 Infrared 940 + \$0 Infrared WHI + \$0 White NWH + \$0 Natural White WWH + \$0 Warm White
		
Standard Dimensions		
W 2.5"		
L 24.50"		
H 1.25"		
Wgt 3.45 lbs		

3 Specify Lens Type 4 Specify Diffuser Option 5 Specify Cable Option

16 **SD** **EC3**
+ \$0 **+ \$0** **+ \$0**

3 Specify Lens Type	4 Specify Diffuser Option	5 Specify Cable Option
12 + \$0 12 Degree Optics 16 + \$0 LED Optics 16 Frosted 23 + \$0 LED Optics 23 Frosted 30 + \$0 30 Degree Frosted Optics 39 + \$0 LED Optics 39 Frosted 50 + \$0 50 Degree Optics F + \$0 Wide Angle Optics R + \$0 LED Reflector 90 R60 + \$0 LED Reflector 60 L + \$0 LED Optics Line	SD + \$0 Standard Diffuser CC + \$25 Clear Cover TFD + \$25 Thin Film Diffuser WD + \$25 White Diffuser P + \$50 Polarizer	EC3 + \$0 E-Series Cable 3M EC5 + \$15 E-Series Cable 5M
12 + \$0 12 Degree Optics 16 + \$0 LED Optics 16 Frosted 23 + \$0 LED Optics 23 Frosted 30 + \$0 30 Degree Frosted Optics 39 + \$0 LED Optics 39 Frosted 50 + \$0 50 Degree Optics F + \$0 Wide Angle Optics R + \$0 LED Reflector 90 R60 + \$0 LED Reflector 60 L + \$0 LED Optics Line	SD + \$0 Standard Diffuser CC + \$50 Clear Cover TFD + \$50 Thin Film Diffuser WD + \$50 White Diffuser P + \$75 Polarizer	EC3 + \$0 E-Series Cable 3M EC5 + \$15 E-Series Cable 5M



MACHINE VISION LIGHTING SINCE 1999

Monster-Series Xtreme Linear Lights



Spectrum Illumination's **Monster-Series Xtreme Linear Lights** are designed for bright field and dark field illumination. X-Series Linear Lights have an aluminum circuit board and single interface housing to dissipate heat. X-Series Burst 3.5x capabilities are protected by thermal auto-resetting circuit.



Units come with light assembly.

Series Highlights

- Internal driver/controller included
- Auto Burst 3.5x Technology
- Ultra-High Power LED's (24 VDC)
- 6 Pin male connector with PNP & NPN
- 6 Pin female tension connector
- Thermal Protection
- Modular end-to-end seamless design
- Available in 3 colors
- Available in 2 sizes and 40mm Spot Light
- 10 Year Warranty* - 100,000 hours

Application Examples

- Automotive and aerospace processing
- Defects and surfaces
- Inspection
- Large surface inspection
- OCR
- Packaging
- Print control

Units come with light assembly.

White
Natural White
Warm White

*10-Year warranty on registered products
*6-Year warranty on non-registered products
*3-year warranty on washdown lights
spectrumillumination/limited-warranty/

P: (231) 894-4590
E: sales@spectrumillumination.com

SpectrumIllumination.com

Monster-Series Xtreme Linear Lights

Features:

- Internal driver/controller included
- Auto Burst 3.5x Technology
- Ultra-High Power LED's (24 VDC)
- 6 Pin male connector quick connect
- 6 Pin female tension connector
- PNP and NPN inputs
- Thermal Protection
- Modular end-to-end seamless design
- Available in 3 colors
- Available in 2 sizes and 40mm Spot Light
- 10 Year Warranty* - 100,000 hours

To Order, Specify;

1 Base Part Number	XL2150
Example:	\$975
2 Specify LED Color	WH
	+ \$0
3 Specify Lens Type	16
	+ \$0
4 Specify Diffuser Type	CC
	+ \$0

1 Base Part Number	List Price	2 LED Color	3 Lens Type	4 Diffuser Type
XL2150	\$975	WHI + \$0 White	16 + \$0 LED Optics 16 Frosted	CC + \$0 Clear Cover
Xtreme Series Double Row 150mm Bar Light With White LED's		NWH + \$0 Natural White	23 + \$0 LED Optics 23 Frosted	SD + \$25 Standard Diffuser
		WWH + \$0 Warm White	39 + \$0 LED Optics 39 Frosted	TFD + \$25 Thin Film Diffuser
Standard Dimensions			R + \$0 LED Reflector 90	WD + \$25 White Diffuser
W 3.842"			R60 + \$0 LED Reflector 60	
L 5.886"			L + \$0 LED Optics Line	
H 1.2"				
Wgt .8 lbs				

XL300	\$1050	WHI + \$0 White	16 + \$0 LED Optics 16 Frosted	CC + \$0 Clear Cover
Xtreme Series 300mm Bar Light With White LED's		NWH + \$0 Natural White	23 + \$0 LED Optics 23 Frosted	SD + \$25 Standard Diffuser
		WWH + \$0 Warm White	39 + \$0 LED Optics 39 Frosted	TFD + \$25 Thin Film Diffuser
Standard Dimensions			R + \$0 LED Reflector 90	WD + \$25 White Diffuser
W 2.675"			R60 + \$0 LED Reflector 60	
L 11.791"			L + \$0 LED Optics Line	
H 1.188"				
Wgt .8 lbs				

Oxy Lights

 [Standard-Series Oxy \(Flat Dome\) Lights - No Driver Required](#) 99-100

SPECTRUM ILLUMINATION MACHINE VISION LIGHTING SINCE 1999



Standard-Series Oxy (Flat Dome) Lights

Spectrum Illumination's Standard-Series Oxy (Flat Dome) Lights are designed to be used on applications that are shiny or uneven. Oxy lights are not recommended for mirrored surfaces. Oxy lights are very compact and more intense than a dome light.

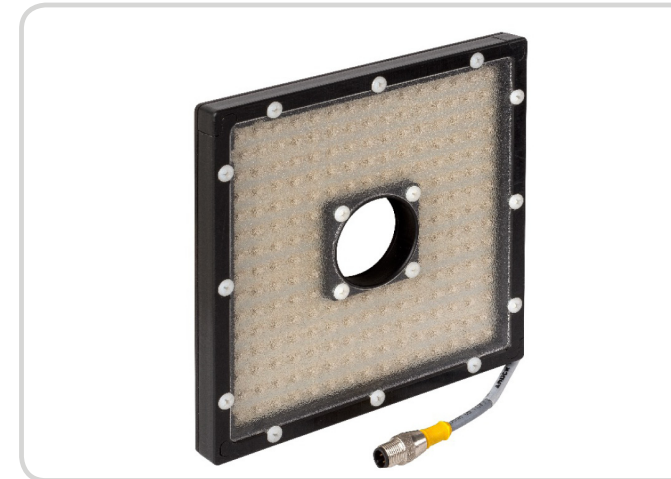

Units come with light and cable.

Series Highlights

- No driver/controller required
- HS (High Speed) Strobe Technology
- 24 VDC
- M12 connector for quick disconnect
- Available in 2 colors and Infrared
- Available in 2 sizes
- 10 Year Warranty* - 100,000 hours

Application Examples

- Automotive and aerospace processing
- Defects on surfaces
- Inspection
- Locate mounting holes
- Pharmaceutical
- View openings (e.g. drilled holes)

Units come with light and cable.

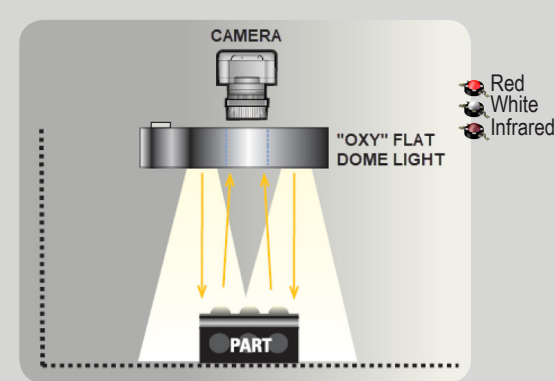

*10-Year warranty on registered products
 *6-Year warranty on non-registered products
 *3-year warranty on washdown lights
spectrumillumination.com/limited-warranty/

P: (231) 894-4590
 E: sales@spectrumillumination.com

SpectrumIllumination.com

Standard-Series Oxy Lights

Features:

- No driver/controller required
- HS (High Speed) Strobe Technology
- 24 VDC
- M12 connector for quick disconnect
- Available in 2 colors and Infrared
- Available in 2 sizes
- 10 Year Warranty* - 100,000 hours

To Order, Specify;

① Base Part Number	OL66
Example:	\$1250
② Specify LED Color	630 + \$0
③ Specify Diffuser Type	SD + \$0
④ Specify Cable Option	SC4 + \$0

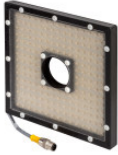
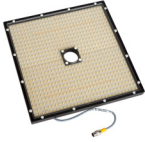

① Base Part Number	List Price	② LED Color	③ Diffuser Type	④ Cable Option
OL66 6" X 6" Oxy Ring Light LED's - Package Includes Light, and 4 Meter Cable  Standard Dimensions W 7" L 7" H .775" Wgt 1.5 lbs	\$1250	630 + \$0 Red	SD + \$0 Standard Diffuser	SC4 + \$0 Standard Cable 4 meter
		880 + \$0 Infrared	TFD + \$25 Thin Film Diffuser	SC8 + \$50 Standard Cable 8 meter
		950 + \$0 Infrared	WD + \$25 White Diffuser	SC15 + \$70 Standard Cable 15 meter
		WHI + \$500 White	P + \$50 Polarizer	SC30 + \$110 Standard Cable 30 meter
				SCHF4 + \$75 Standard High Flex Cable 4 meter
			SCHF8 + \$100 Standard High Flex Cable 8 meter	
			SCHF15 + \$150 Standard High Flex Cable 15 meter	
OL1212 12" X 12" Oxy Ring Light LED - Package Includes Light, and 4 Meter Cable  Standard Dimensions W 13" L 13" H .775" Wgt 4.45 lbs	\$2750	630 + \$0 Red	SD + \$0 Standard Diffuser	SC4 + \$0 Standard Cable 4 meter
		880 + \$0 Infrared	TFD + \$50 Thin Film Diffuser	SC8 + \$50 Standard Cable 8 meter
		950 + \$0 Infrared	WD + \$75 White Diffuser	SC15 + \$70 Standard Cable 15 meter
		WHI + \$1000 White	P + \$75 Polarizer	SC30 + \$110 Standard Cable 30 meter
				SCHF4 + \$75 Standard High Flex Cable 4 meter
			SCHF8 + \$100 Standard High Flex Cable 8 meter	
			SCHF15 + \$150 Standard High Flex Cable 15 meter	

This page is intentionally blank

Back Lights
Diffused Axial
Dome Lights
Linear Lights
Oxy Lights
Ring Lights
Spot Lights
TriPod Lights
Washdown Lights
Controllers & Cables

Back Lights
Diffused Axial
Dome Lights
Linear Lights
Oxy Lights
Ring Lights
Spot Lights
TriPod Lights
Washdown Lights
Controllers & Cables

Ring Lights

 Standard-Series Ring Lights - No Driver Required	103-107
 Monster-Series Ring Lights - External Driver Included	109-121



MACHINE VISION LIGHTING SINCE 1999



Standard-Series Ring “Bright Field” Lights

Spectrum Illumination’s Standard-Series Ring “Bright Field” Lights are designed for bright field and dark field applications. Dark field lights are used to illuminate edges and surface defects.



The 4 arrays on the RL/DF Ring Lights are adjustable, it can be adjusted from 0 – 90 degrees so that edges and features are illuminated properly.





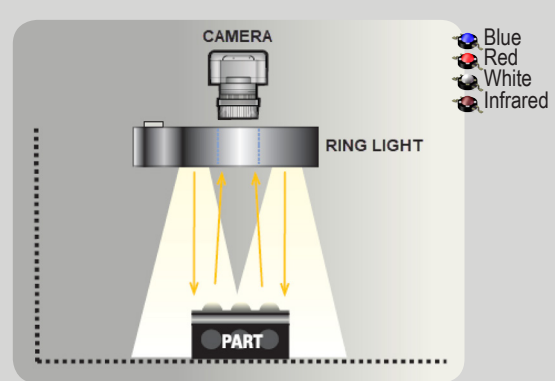

Units come with light and cable.

Series Highlights

- No driver/controller required
- HS (High Speed) Strobe Technology
- 24 VDC
- M12 connector for quick disconnect
- Available in 2-3 colors, Ultra-Violet, and Infrared
- Available in 4 sizes
- 10 Year Warranty* - 100,000 hours

Units come with light and cable.



Blue
 Red
 White
 Infrared

CAMERA
 RING LIGHT
 PART

*10-Year warranty on registered products
 *6-Year warranty on non-registered products
 *3-year warranty on washdown lights
spectrumillumination.com/limited-warranty/

Application Examples

- Defects on surfaces
- Food and Beverage
- Homogeneous / direct lighting
- Inspection of assembly
- OCR
- Part recognition
- Pharmaceutical
- Print control

P: (231) 894-4590
E: sales@spectrumillumination.com

SpectrumIllumination.com

Standard-Series Ring Lights

Features:

- No driver/controller required
- HS (High Speed) Strobe Technology
- 24 VDC
- M12 connector for quick disconnect
- Available in 2-3 colors, Ultra-Violet, and Infrared
- Available in 4 sizes
- 10 Year Warranty* - 100,000 hours

To Order, Specify;

1 Base Part Number	RL/DF4
Example:	\$1375
2 Specify LED Color	880 + \$0
3 Specify Diffuser Type	SD + \$0
4 Specify Cable Option	SC4 + \$0

1 Base Part Number	List Price	2 LED Color	3 Diffuser Type	4 Cable Option
RL/DF4 4" X 4" Ring Light Adjustable Dark Field - Package Includes Light, and 4 Meter Cable	\$1375	880 + \$0 Infrared 630 + \$0 Red	SD + \$0 Standard Diffuser TFD + \$75 Thin Film Diffuser WD + \$75 White Diffuser P + \$75 Polarizer	SC4 + \$0 Standard Cable 4 meter SC8 + \$50 Standard Cable 8 meter SC15 + \$70 Standard Cable 15 meter SC30 + \$110 Standard Cable 30 meter SCHF4 + \$75 Standard High Flex Cable 4 meter SCHF8 + \$100 Standard High Flex Cable 8 meter SCHF15 + \$150 Standard High Flex Cable 15 meter
				
Standard Dimensions				
W 10"				
L 10"				
H 1.875"				
Wgt 5.85 lbs				

RL/DF8 8" X 8" Ring Light Adjustable Dark Field - Package Includes Light, and 4 Meter Cable	\$2150	880 + \$0 Infrared 630 + \$0 Red	SD + \$0 Standard Diffuser TFD + \$125 Thin Film Diffuser WD + \$125 White Diffuser P + \$125 Polarizer	SC4 + \$0 Standard Cable 4 meter SC8 + \$50 Standard Cable 8 meter SC15 + \$70 Standard Cable 15 meter SC30 + \$110 Standard Cable 30 meter SCHF4 + \$75 Standard High Flex Cable 4 meter SCHF8 + \$100 Standard High Flex Cable 8 meter SCHF15 + \$150 Standard High Flex Cable 15 meter
				
Standard Dimensions				
W 14"				
L 14"				
H 1.875"				

Standard-Series Ring Lights

Features:

- No driver/controller required
- HS (High Speed) Strobe Technology
- 24 VDC
- M12 connector for quick disconnect
- Available in 2 colors, Ultra-Violet, and Infrared
- Available in 4 sizes
- 10 Year Warranty* - 100,000 hours

To Order, Specify;

1 Base Part Number	RL4
Example:	\$575
2 Specify LED Color	630 + \$0
3 Specify Diffuser Type	SD + \$0
4 Specify Cable Option	SC4 + \$0

1 Base Part Number	List Price	2 LED Color	3 Diffuser Type	4 Cable Option
RL4 4" Ring Light LED - Package Includes Light, and 4 Meter Cable	\$575	630 + \$0 Red 880 + \$0 Infrared WHI + \$100 White	SD + \$0 Standard Diffuser CC + \$25 Clear Cover TFD + \$25 Thin Film Diffuser WD + \$25 White Diffuser P + \$25 Polarizer	SC4 + \$0 Standard Cable 4 meter SC8 + \$50 Standard Cable 8 meter SC15 + \$70 Standard Cable 15 meter SC30 + \$110 Standard Cable 30 meter SCHF4 + \$75 Standard High Flex Cable 4 meter SCHF8 + \$100 Standard High Flex Cable 8 meter SCHF15 + \$150 Standard High Flex Cable 15 meter
				
Standard Dimensions				
Dia 4.75"				
CC 14.915"				
H 1.125"				
Wgt .7 lbs				

RL70 Pelco Ring Lights Board with Wide or Medium Angle Lenses	\$235	W-WHI + \$0 Wide Angle White W-470 + \$0 Wide Angle Blue W-630 + \$0 Wide Angle Red M-630 + \$0 Medium Angle Red M-880 + \$0 Medium Angle Infrared W-880 + \$0 Wide Angle Infrared	No Options	No Options
				
Standard Dimensions				
W 2.7"				
L 3.015"				

Standard-Series Ring Lights

Features:

- Internal driver/controller included
- HS (High Speed) Strobe Technology
- 24 VDC
- M12 connector for quick disconnect
- Available in 4 colors, Ultra-Violet and Infrared
- Available in 4 sizes
- 10 Year Warranty* - 100,000 hours

To Order, Specify;

① Base Part Number

Example: **RLD3** **470**
\$450 **+ \$0**

② Specify LED Color

① Base Part Number	List Price	② Specify LED Color
RLD3 3" Ring Light LED and 4 Meter Cable	\$450	470 + \$0 Blue
 <p>Standard Dimensions</p> <p>W 2.7" L 3.4" H 1.15"</p>		530 + \$0 Green
		630 + \$0 Red
		850 + \$0 Infrared
		WHI + \$0 White
		395 + \$0 UV 395NM HB LED

③ Specify Lens Type ④ Specify Diffuser Type ⑤ Specify Cable Option

12 **SD** **SC4-5**
+ \$0 **+ \$0** **+ \$0**

③ Specify Lens Type	④ Specify Diffuser Type	⑤ Specify Cable Option
12 + \$0 12 Degree Optics	SD + \$0 Standard Diffuser	SC4-5 + \$0 Standard Cable 4 meter 5 wire
50 + \$0 50 Degree Optics	CC + \$25 Clear Cover	SC8-5 + \$40 Standard Cable 8 meter 5 wire
F + \$0 Wide Angle Optics	TFD + \$25 Thin Film Diffuser	
	WD + \$25 White Diffuser	
	P + \$25 Polarizer	

This page is intentionally blank



MACHINE VISION LIGHTING SINCE 1999

Monster-Series Ring “Bright Field” Lights



Spectrum Illumination’s Monster-Series Ring “Bright Field” Lights are designed for bright field applications that require a large area of coverage and/or long work distance.



Units come with light, driver(s) / controller(s) and cable.

Series Highlights

- External driver/controller included
- HS (High Speed) Strobe Technology
- High Power LED’s (24 VDC)
- M12 connector for quick disconnect
- Available in 8 colors, Ultra-Violet, and Infrared
- Available in 7 sizes
- 10 Year Warranty* - 100,000 hours

Units come with light, driver(s) / controller(s) and cable.

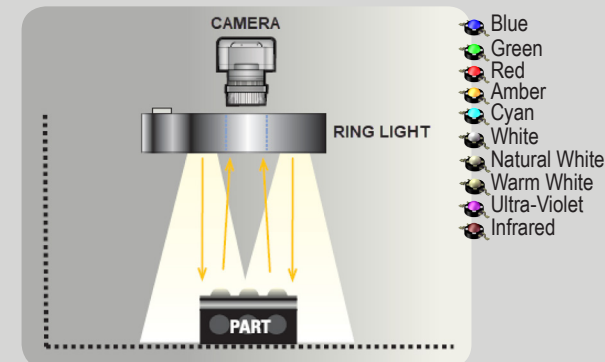

Application Examples

- Defects on surfaces
- Food and Beverage
- Homogeneous / direct lighting
- Inspection of assembly
- OCR
- Part recognition
- Pharmaceutical
- Print control

*10-Year warranty on registered products
 *6-Year warranty on non-registered products
 *3-year warranty on washdown lights
 spectrumillumination/limited-warranty/

P: (231) 894-4590
 E: sales@spectrumillumination.com

SpectrumIllumination.com

Monster-Series Ring Lights

Features:

- External driver/controller included
- HS (High Speed) Strobe Technology
- High Power LED's (24 VDC)
- M12 connector for quick disconnect
- Available in 8 colors, Ultra-Violet, and Infrared
- Available in 7 sizes
- 10 Year Warranty* - 100,000 hours

Caution –

The supplied LDM adapter must be used for both continuous or strobe operations! Do not connect the fixture directly to 24VDC! Operating the fixture without the supplied LDM adapter will result in premature LED failure and will void the warranty.

To Order, Specify;			
1 Base Part Number			
Example:	RL2.5	395	12
	\$450	+ \$0	+ \$0
2 Specify LED Color		3 Specify Lens Type	

1 Base Part Number	List Price	2 Specify LED Color	3 Specify Lens Type
RL2.5 2.5" Ring Light LED - Package Includes Light, LDM 350/2, and 4 Meter Cable	\$450	395 + \$0 UV 395NM HB LED 940 + \$0 Infrared	12 + \$0 12 Degree Optics 50 + \$0 50 Degree Optics F + \$0 Wide Angle Optics



Standard Dimensions

W	2.375"
L	2.375"
H	1.125"
Wgt	.35 lbs

MRL2.5 2.5" Ring Light LED - Package Includes Light, LDM 350/2, and 4 Meter Cable	\$450	365 + \$400 UV 365NM HB LED 470 + \$0 Blue 505 + \$0 Cyan 530 + \$0 Green 590 + \$0 Amber 630 + \$0 Red 850 + \$0 Infrared WHI + \$0 White	12 + \$0 12 Degree Optics 50 + \$0 50 Degree Optics F + \$0 Wide Angle Optics
---	--------------	---	---



Standard Dimensions

W	2.375"
L	2.375"
H	1.125"
Wgt	.35 lbs

4 Specify Diffuser Option	5 Specify Cable Option	6 Specify Driver Option
SD + \$0	MC4 + \$0	A + \$85

4 Specify Diffuser Option	5 Specify Cable Option	6 Specify Driver Option
SD + \$0 Standard Diffuser	MC4 + \$0 Monster Cable 4 meter	LDM350/2 + \$0 350mA 2-4 LED Driver DIN Rail Mount
CC + \$25 Clear Cover	MC8 + \$40 Monster Cable 8 meter	A + \$85 ALDM Driver
TFD + \$25 Thin Film Diffuser	MC15 + \$60 Monster Cable 15 meter	V + \$85 VLDM Driver
WD + \$25 White Diffuser	MC30 + \$195 Monster Cable 30 meter	RV + \$100 RVLDM Driver
P + \$25 Polarizer	MCHF4 + \$75 Monster High Flex Cable 4 meter	
	MCHF8 + \$100 Monster High Flex Cable 8 meter	
	MCHF15 + \$200 Monster High Flex Cable 15 meter	
	MCHF30 + \$380 Monster High Flex Cable 30 meter	

SD + \$0 Standard Diffuser	MC4 + \$0 Monster Cable 4 meter	LDM350/2 + \$0 350mA 2-4 LED Driver DIN Rail Mount
CC + \$25 Clear Cover	MC8 + \$40 Monster Cable 8 meter	A + \$85 ALDM Driver
TFD + \$25 Thin Film Diffuser	MC15 + \$60 Monster Cable 15 meter	V + \$85 VLDM Driver
WD + \$25 White Diffuser	MC30 + \$195 Monster Cable 30 meter	RV + \$100 RVLDM Driver
P + \$25 Polarizer	MCHF4 + \$75 Monster High Flex Cable 4 meter	
	MCHF8 + \$100 Monster High Flex Cable 8 meter	
	MCHF15 + \$200 Monster High Flex Cable 15 meter	
	MCHF30 + \$380 Monster High Flex Cable 30 meter	

Monster-Series Ring Lights



Features:

- External driver/controller included
- HS (High Speed) Strobe Technology
- High Power LED's (24 VDC)
- M12 connector for quick disconnect
- Available in 8 colors, Ultra-Violet, and Infrared
- Available in 7 sizes
- 10 Year Warranty* - 100,000 hours

Caution –

The supplied LDM adapter must be used for both continuous or strobe operations! Do not connect the fixture directly to 24VDC! Operating the fixture without the supplied LDM adapter will result in premature LED failure and will void the warranty.

To Order, Specify;			
1 Base Part Number			
Example:	RL3.5	395	12
	\$725	+ \$0	+ \$0
2 Specify LED Color		3 Specify Lens Type	

1 Base Part Number	List Price	2 Specify LED Color	3 Specify Lens Type
RL3.5 3.5" Ring Light LED - Package Includes Light, LDM 700, and 4 Meter Cable	\$725	395 + \$0 UV 395NM HB LED	12 + \$0 12 Degree Optics 16 + \$0 LED Optics 16 Frosted 23 + \$0 LED Optics 23 Frosted 30 + \$0 30 Degree Frosted Optics 39 + \$0 LED Optics 39 Frosted 50 + \$0 50 Degree Optics F + \$0 Wide Angle Optics R + \$0 LED Reflector 90 R60 + \$0 LED Reflector 60 L + \$0 LED Optics Line
 Standard Dimensions Dia 4.375" CC 13.738" H 1.125" Wgt .85 lbs			
MRL3.5 3.5" Ring Light LED's - Package Includes Light, LDM 700, and 4 Meter Cable	\$725	365 + \$200 UV 365NM HB LED 470 + \$0 Blue 505 + \$0 Cyan 530 + \$0 Green 590 + \$0 Amber 630 + \$0 Red 850 + \$0 Infrared WHI + \$0 White NWH + \$0 Natural White WWH + \$0 Warm White	12 + \$0 12 Degree Optics 16 + \$0 LED Optics 16 Frosted 23 + \$0 LED Optics 23 Frosted 30 + \$0 30 Degree Frosted Optics 39 + \$0 LED Optics 39 Frosted 50 + \$0 50 Degree Optics F + \$0 Wide Angle Optics R + \$0 LED Reflector 90 R60 + \$0 LED Reflector 60 L + \$0 LED Optics Line
 Standard Dimensions Dia 4.375" CC 13.738" H 1.125" Wgt .85 lbs			

4 Specify Diffuser Option	5 Specify Cable Option	6 Specify Driver Option
SD + \$0	MC4 + \$0	A + \$85

4 Specify Diffuser Option	5 Specify Cable Option	6 Specify Driver Option
SD + \$0 Standard Diffuser CC + \$25 Clear Cover TFD + \$25 Thin Film Diffuser WD + \$25 White Diffuser P + \$25 Polarizer	MC4 + \$0 Monster Cable 4 meter MC8 + \$40 Monster Cable 8 meter MC15 + \$60 Monster Cable 15 meter MC30 + \$195 Monster Cable 30 meter MCHF4 + \$75 Monster High Flex Cable 4 meter MCHF8 + \$100 Monster High Flex Cable 8 meter MCHF15 + \$200 Monster High Flex Cable 15 meter MCHF30 + \$380 Monster High Flex Cable 30 meter	LDM700 + \$0 700mA LED Driver DIN Rail Mount A + \$85 ALDM Driver V + \$85 VLDM Driver RV + \$100 RVLDM Driver

SD + \$0 Standard Diffuser CC + \$25 Clear Cover TFD + \$25 Thin Film Diffuser WD + \$25 White Diffuser P + \$25 Polarizer	MC4 + \$0 Monster Cable 4 meter MC8 + \$40 Monster Cable 8 meter MC15 + \$60 Monster Cable 15 meter MC30 + \$195 Monster Cable 30 meter MCHF4 + \$75 Monster High Flex Cable 4 meter MCHF8 + \$100 Monster High Flex Cable 8 meter MCHF15 + \$200 Monster High Flex Cable 15 meter MCHF30 + \$380 Monster High Flex Cable 30 meter	LDM700 + \$0 700mA LED Driver DIN Rail Mount A + \$85 ALDM Driver V + \$85 VLDM Driver RV + \$100 RVLDM Driver
--	---	---

Back Lights
Diffused Axial
Dome Lights
Linear Lights
Oxy Lights
Ring Lights
Spot Lights
TriPod Lights
Washdown Lights
Controllers & Cables

Back Lights
Diffused Axial
Dome Lights
Linear Lights
Oxy Lights
Ring Lights
Spot Lights
TriPod Lights
Washdown Lights
Controllers & Cables

Monster-Series Ring Lights



Features:

- External driver/controller included
- HS (High Speed) Strobe Technology
- High Power LED's (24 VDC)
- M12 connector for quick disconnect
- Available in 8 colors, Ultra-Violet, and Infrared
- Available in 7 sizes
- 10 Year Warranty* - 100,000 hours

Caution –

The supplied LDM adapter must be used for both continuous or strobe operations! Do not connect the fixture directly to 24VDC! Operating the fixture without the supplied LDM adapter will result in premature LED failure and will void the warranty.

To Order, Specify;				
1 Base Part Number	Example: MRL5.5-XXX-YYY			
	470	530	12	
	\$1300	+ \$0	+ \$0	+ \$0
2 Specify LED Color	3 Specify Lens Type			

1 Base Part Number	List Price	2 Specify LED Color		3 Specify Lens Type		
		Channel 1	Channel 2			
MRL5.5-XXX-YYY 5.5" Ring Light, 2 Channels/ colors of LED, 2 LDM 700s, and 4 Meter Cable  Standard Dimensions Dia 6.75" CC 21.2" H 1.125"	\$1300	365 + \$250 UV 365NM HB LED	365 + \$250 UV 365NM HB LED	12 + \$0 12 Degree Optics		
		395 + \$0 UV 395NM HB LED	395 + \$0 UV 395NM HB LED	16 + \$0 LED Optics 16 Frosted		
		470 + \$0 Blue	470 + \$0 Blue	23 + \$0 LED Optics 23 Frosted		
		530 + \$0 Green	530 + \$0 Green	30 + \$0 30 Degree Frosted Optics		
		630 + \$0 Red	630 + \$0 Red	39 + \$0 LED Optics 39 Frosted		
		850 *Call for Price Infrared	850 *Call for Price Infrared	50 + \$0 50 Degree Optics		
		940 *Call for Price Infrared	940 *Call for Price Infrared	F + \$0 Wide Angle Optics		
		WHI + \$0 White	WHI + \$0 White	R + \$0 LED Reflector 90		
		NWH + \$0 Natural White	NWH + \$0 Natural White	R60 + \$0 LED Reflector 60		
		WWH + \$0 Warm White	WWH + \$0 Warm White	L + \$0 LED Optics Line		
		MRL5.5 5.5" Ring Light LED - Package Includes Light, LDM 700, and 4 Meter Cable  Standard Dimensions Dia 6.75" CC 21.195" H 1.125" Wgt 1.5 lbs	\$1000	365 + \$500 UV 365NM HB LED		12 + \$0 12 Degree Optics
				395 + \$0 UV 395NM HB LED		16 + \$0 LED Optics 16 Frosted
				940 + \$0 Infrared		23 + \$0 LED Optics 23 Frosted
470 + \$0 Blue				30 + \$0 30 Degree Frosted Optics		
505 + \$0 Cyan				39 + \$0 LED Optics 39 Frosted		
530 + \$0 Green				50 + \$0 50 Degree Optics		
590 + \$0 Amber				F + \$0 Wide Angle Optics		
630 + \$0 Red				R + \$0 LED Reflector 90		
850 + \$0 Infrared				R60 + \$0 LED Reflector 60		
WHI + \$0 White				L + \$0 LED Optics Line		
NWH + \$0 Natural White						
WWH + \$0 Warm White						

4 Specify Diffuser Option	5 Specify Cable Option	6 Specify Driver Option
SD + \$0	MC4 + \$0	A + \$170

4 Specify Diffuser Option	5 Specify Cable Option	6 Specify Driver Option
SD + \$0 Standard Diffuser	MC4 + \$0 Monster Cable 4 meter	LDM700 + \$0 700mA LED Driver DIN rail mount
CC + \$25 Clear Cover	MC8 + \$40 Monster Cable 8 meter	A + \$170 ALDM Driver
TFD + \$25 Thin Film Diffuser	MC15 + \$60 Monster Cable 15 meter	V + \$170 VLDM Driver
WD + \$25 White Diffuser	MC30 + \$195 Monster Cable 30 meter	RV + \$200 RVLDM Drive
P + \$25 White Diffuser	MCHF4 + \$75 Monster High Flex Cable 4 meter	
	MCHF8 + \$100 Monster High Flex Cable 8 meter	
	MCHF15 + \$200 Monster High Flex Cable 15 meter	
	MCHF30 + \$380 Monster High Flex Cable 30 meter	

SD + \$0 Standard Diffuser	MC4 + \$0 Monster Cable 4 meter	LDM700 + \$0 700mA LED Driver DIN Rail Mount
CC + \$25 Clear Cover	MC8 + \$40 Monster Cable 8 meter	A + \$85 ALDM Driver
TFD + \$25 Thin Film Diffuser	MC15 + \$60 Monster Cable 15 meter	V + \$85 VLDM Driver
WD + \$25 White Diffuser	MC30 + \$195 Monster Cable 30 meter	RV + \$100 RVLDM Driver
P + \$25 Polarizer	MCHF4 + \$75 Monster High Flex Cable 4 meter	
	MCHF8 + \$100 Monster High Flex Cable 8 meter	
	MCHF15 + \$200 Monster High Flex Cable 15 meter	
	MCHF30 + \$380 Monster High Flex Cable 30 meter	

Monster-Series Ring Lights

Features:



- External driver/controller included
- HS (High Speed) Strobe Technology
- High Power LED's (24 VDC)
- M12 connector for quick disconnect
- Available in 8 colors, Ultra-Violet, and Infrared
- Available in 7 sizes
- 10 Year Warranty* - 100,000 hours

Caution –

The supplied LDM adapter must be used for both continuous or strobe operations! Do not connect the fixture directly to 24VDC! Operating the fixture without the supplied LDM adapter will result in premature LED failure and will void the warranty.

To Order, Specify;

1 Base Part Number	Example:	
	MRL8.5	470 12
	\$1550	+ \$0 + \$0
2 Specify LED Color	3 Specify Lens Type	

1 Base Part Number	List Price	2 Specify LED Color	3 Specify Lens Type
MRL8.5 8.5" Ring Light LED - Package Includes Light, LDM 700, and 4 Meter Cable	\$1550	365 + \$450 UV 365NM HB LED 395 + \$0 UV 395NM HB LED 470 + \$0 Blue 505 + \$0 Cyan 530 + \$0 Green 590 + \$0 Amber 630 + \$0 Red 850 + \$0 Infrared WHI + \$0 White NWH + \$0 Natural White WWH + \$0 Warm White	12 + \$0 12 Degree Optics 16 + \$0 LED Optics 16 Frosted 23 + \$0 LED Optics 23 Frosted 30 + \$0 30 Degree Frosted Optics 39 + \$0 LED Optics 39 Frosted 50 + \$0 50 Degree Optics F + \$0 Wide Angle Optics R + \$0 LED Reflector 90 R60 + \$0 LED Reflector 60 L + \$0 LED Optics Line
 Standard Dimensions Dia 12" CC 37.68" H 1.25" Wgt 4.71 lbs			
MRL13.5 13.5" Ring Light LED - Package Includes Light, LDM 1400, and 4 Meter Cable	\$1850	365 * Call for Price UV 365NM HB LED 395 + \$0 UV 395NM HB LED 470 + \$0 Blue 505 + \$0 Cyan 530 + \$0 Green 590 + \$0 Amber 630 + \$0 Red 850 + \$0 Infrared WHI + \$0 White NWH + \$0 Natural White WWH + \$0 Warm White	12 + \$0 12 Degree Optics 16 + \$0 LED Optics 16 Frosted 23 + \$0 LED Optics 23 Frosted 30 + \$0 30 Degree Frosted Optics 39 + \$0 LED Optics 39 Frosted 50 + \$0 50 Degree Optics F + \$0 Wide Angle Optics R + \$0 LED Reflector 90 R60 + \$0 LED Reflector 60 L + \$0 LED Optics Line
 Standard Dimensions Dia 16.875" CC 52.987" H 1.25"			

4 Specify Diffuser Option	5 Specify Cable Option	6 Specify Driver Option
SD + \$0	MC4 + \$0	A + \$85

4 Specify Diffuser Option	5 Specify Cable Option	6 Specify Driver Option
SD + \$0 Standard Diffuser CC + \$50 Clear Cover TFD + \$50 Thin Film Diffuser WD + \$50 White Diffuser	MC4 + \$0 Monster Cable 4 meter MC8 + \$40 Monster Cable 8 meter MC15 + \$60 Monster Cable 15 meter MC30 + \$195 Monster Cable 30 meter MCHF4 + \$75 Monster High Flex Cable 4 meter MCHF8 + \$100 Monster High Flex Cable 8 meter MCHF15 + \$200 Monster High Flex Cable 15 meter MCHF30 + \$380 Monster High Flex Cable 30 meter	LDM700 + \$0 700mA LED Driver DIN Rail Mount A + \$85 ALDM Driver V + \$85 VLDM Driver RV + \$100 RVLDM Driver
SD + \$0 Standard Diffuser CC + \$75 Clear Cover TFD + \$75 Thin Film Diffuser WD + \$75 White Diffuser	MC4 + \$0 Monster Cable 4 meter MC8 + \$40 Monster Cable 8 meter MC15 + \$60 Monster Cable 15 meter MC30 + \$195 Monster Cable 30 meter MCHF4 + \$75 Monster High Flex Cable 4 meter MCHF8 + \$100 Monster High Flex Cable 8 meter MCHF15 + \$200 Monster High Flex Cable 15 meter MCHF30 + \$380 Monster High Flex Cable 30 meter	LDM1400 + \$0 1400mA LED Driver DIN Rail Mount A + \$85 ALDM Driver V + \$85 VLDM Driver RV + \$100 RVLDM Driver

Back Lights
Diffused Axial
Dome Lights
Linear Lights
Oxy Lights
Ring Lights
Spot Lights
TriPod Lights
Washdown Lights
Controllers & Cables

Back Lights
Diffused Axial
Dome Lights
Linear Lights
Oxy Lights
Ring Lights
Spot Lights
TriPod Lights
Washdown Lights
Controllers & Cables

Monster-Series Ring Lights



Features:

- External driver/controller included
- HS (High Speed) Strobe Technology
- High Power LED's (24 VDC)
- M12 connector for quick disconnect
- Available in 8 colors, Ultra-Violet, and Infrared
- Available in 7 sizes
- 10 Year Warranty* - 100,000 hours

Caution –

The supplied LDM adapter must be used for both continuous or strobe operations! Do not connect the fixture directly to 24VDC! Operating the fixture without the supplied LDM adapter will result in premature LED failure and will void the warranty.

To Order, Specify;			
1 Base Part Number	Example:		
	MRL19.5	395	12
	\$3000	+ \$0	+ \$0
2 Specify LED Color	3 Specify Lens Type		

1 Base Part Number	List Price	2 Specify LED Color	3 Specify Lens Type
MRL19.5 19.5" Ring Light LED- Package Includes Light, LDM 2100, and 4 Meter Cable	\$3000	365 * Call for Price UV 365NM HB LED 395 + \$0 UV 395NM HB LED 470 + \$0 Blue 505 + \$0 Cyan 530 + \$0 Green 590 + \$0 Amber 630 + \$0 Red 850 + \$0 Infrared WHI + \$0 White NWH + \$0 Natural White WWH + \$0 Warm White	12 + \$0 12 Degree Optics 16 + \$0 LED Optics 16 Frosted 23 + \$0 LED Optics 23 Frosted 30 + \$0 30 Degree Frosted Optics 39 + \$0 LED Optics 39 Frosted 50 + \$0 50 Degree Optics F + \$0 Wide Angle Optics R + \$0 LED Reflector 90 R60 + \$0 LED Reflector 60 L + \$0 LED Optics Line
	Standard Dimensions Dia 23.125" CC 72.612" H 1.25"		
MRL30.5 30.5" Ring Light LED - Package Includes Light, LDM 2800 and 4 Meter Cable	\$4500	365 * Call for Price UV 365NM HB LED 395 + \$0 UV 395NM HB LED 470 + \$0 Blue 505 + \$0 Cyan 530 + \$0 Green 590 + \$0 Amber 630 + \$0 Red 850 + \$0 Infrared WHI + \$0 White NWH + \$0 Natural White WWH + \$0 Warm White	12 + \$0 12 Degree Optics 16 + \$0 LED Optics 16 Frosted 23 + \$0 LED Optics 23 Frosted 30 + \$0 30 Degree Frosted Optics 39 + \$0 LED Optics 39 Frosted 50 + \$0 50 Degree Optics F + \$0 Wide Angle Optics R + \$0 LED Reflector 90 R60 + \$0 LED Reflector 60 L + \$0 LED Optics Line
	Standard Dimensions Dia 34" CC 106.76" H 1.25"		

4 Specify Diffuser Option	5 Specify Cable Option	6 Specify Driver Option
SD + \$0	MC4 + \$0	A + \$85

4 Specify Diffuser Option	5 Specify Cable Option	6 Specify Driver Option
SD + \$0 Standard Diffuser CC + \$100 Clear Cover TFD + \$100 Thin Film Diffuser WD + \$100 White Diffuser	MC4 + \$0 Monster Cable 4 meter MC8 + \$40 Monster Cable 8 meter MC15 + \$60 Monster Cable 15 meter MC30 + \$195 Monster Cable 30 meter MCHF4 + \$75 Monster High Flex Cable 4 meter MCHF8 + \$100 Monster High Flex Cable 8 meter MCHF15 + \$200 Monster High Flex Cable 15 meter MCHF30 + \$380 Monster High Flex Cable 30 meter	LDM2100 + \$0 2100mA LED Driver DIN Rail Mount A + \$85 ALDM Driver V + \$85 VLDM Driver RV + \$100 RVLDM Driver
SD + \$0 Standard Diffuser CC + \$250 Clear Cover TFD + \$250 Thin Film Diffuser WD + \$250 White Diffuser	MC4 + \$0 Monster Cable 4 meter MC8 + \$40 Monster Cable 8 meter MC15 + \$60 Monster Cable 15 meter MC30 + \$195 Monster Cable 30 meter MCHF4 + \$75 Monster High Flex Cable 4 meter MCHF8 + \$100 Monster High Flex Cable 8 meter MCHF15 + \$200 Monster High Flex Cable 15 meter MCHF30 + \$380 Monster High Flex Cable 30 meter	LDM2800 + \$0 2800mA LED Driver DIN Rail Mount A + \$85 ALDM Driver V + \$85 VLDM Driver RV + \$100 RVLDM Driver

Monster-Series Ring Lights with Internal Driver

Features:

- Internal Driver - Plug & Play
- Auto Burst Technology
- High Power LED's (24 VDC)
- M12 connector for quick disconnect
- Available in 8 colors, Ultra-Violet, and Infrared
- Available in 2 sizes
- 0 - 10 VDC intensity Control
- Potentiometer Intensity Control
- 10 Year Warranty* - 100,000 hours



To Order, Specify;

① Base Part Number

Example: **MRLD3.5 395 12**
\$200 + \$0 + \$0

② Specify LED Color ③ Specify Lens Type



① Base Part Number	List Price	② Specify LED Color	③ Specify Lens Type		
MRLD3.5 3.5" Ring Light LED - Package Includes Light and 3 Meter Cable  Standard Dimensions Dia .375" CC 3.738" H 1.125" Wgt .85 lbs	\$700	365 + \$200 UV 365NM HB LED	12 + \$0 12 Degree Optics		
		395 + \$0 UV 395NM HB LED	16 + \$0 LED Optics 16 Frosted		
		470 + \$0 Blue	23 + \$0 LED Optics 23 Frosted		
		505 + \$0 Cyan	30 + \$0 30 Degree Frosted Optics		
		530 + \$0 Green	39 + \$0 LED Optics 39 Frosted		
		590 + \$0 Amber	50 + \$0 50 Degree Optics		
		630 + \$0 Red	F + \$0 Wide Angle Optics		
		850 + \$0 Infrared	R + \$0 LED Reflector 90		
		WHI + \$0 White	R60 + \$0 LED Reflector 60		
		NWH + \$0 Natural White	L + \$0 LED Optics Line		
		WWH + \$0 Warm White			
		MRLD5.5 5.5" Ring Light LED's - Package Includes Light and 3 Meter Cable  Standard Dimensions Dia 34" CC 106.76" H 1.25"	\$975	365 + \$500 UV 365NM HB LED	12 + \$0 12 Degree Optics
				395 + \$0 UV 395NM HB LED	16 + \$0 LED Optics 16 Frosted
				470 + \$0 Blue	23 + \$0 LED Optics 23 Frosted
				505 + \$0 Cyan	30 + \$0 30 Degree Frosted Optics
530 + \$0 Green	39 + \$0 LED Optics 39 Frosted				
590 + \$0 Amber	50 + \$0 50 Degree Optics				
630 + \$0 Red	F + \$0 Wide Angle Optics				
850 + \$0 Infrared	R + \$0 LED Reflector 90				
WHI + \$0 White	R60 + \$0 LED Reflector 60				
NWH + \$0 Natural White	L + \$0 LED Optics Line				
WWH + \$0 Warm White					



④ Specify Diffuser Option ⑤ Specify Cable Option

SD + \$0	EC3 + \$0
---------------------------	----------------------------

④ Specify Diffuser Option	⑤ Specify Cable Option
SD + \$0 Standard Diffuser	EC3 + \$0 3 Meter Cable
CC + \$25 Clear Cover	EC5 + \$15 5 Meter Cable
TFD + \$25 Thin Film Diffuser	
WD + \$25 White Diffuser	

SD + \$0 Standard Diffuser	EC3 + \$0 3 Meter Cable
CC + \$25 Clear Cover	EC5 + \$15 5 Meter Cable
TFD + \$25 Thin Film Diffuser	
WD + \$25 White Diffuser	

Spot Lights

 E-Series Spot Lights - Internal Driver Included	123-125
 Monster-Series Spot Lights - External Driver Included	127-131
 Monster-Series Xtreme Spot Lights - Internal Driver Included	133-135



MACHINE VISION LIGHTING SINCE 1999

E-Series Spot Lights



Spectrum Illumination's **E-Series Spot Lights** are used for both bright field and dark field illumination. E-Series Spot Lights have an aluminum circuit board and single interface housing to dissipate heat. E-Series Burst 3.5x capabilities are protected by a thermal auto-resetting circuit.



Units come with light and cable.

Units come with light and cable.

Series Highlights

- Internal driver/controller included
- Auto Burst 3.5x Technology
- Thermal Protection to reduce downtime
- High Power LED's (24 VDC)
- Internal driver/controller
- M12 connector for quick disconnect
- Available in 5 colors, Ultra-Violet, and Infrared
- Available in 1 size and 40mm Spot Light
- 10 Year Warranty* - 50,000 hours

Units come with light and cable.

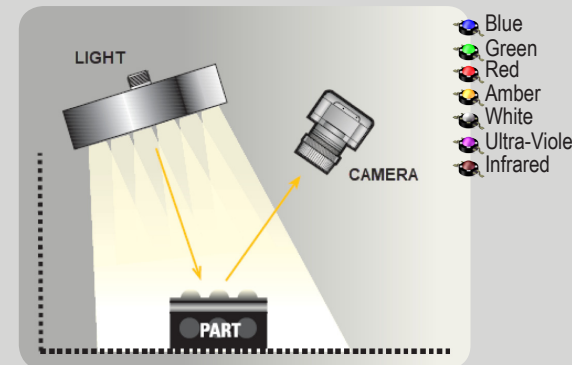

Application Examples

- Automotive and aerospace processing
- Defects on surfaces
- Inspection
- Large surface inspection
- OCR Optical Character Reading
- Packaging
- Print control

*10-Year warranty on registered products
 *6-Year warranty on non-registered products
 *3-year warranty on washdown lights
spectrumillumination.com/limited-warranty/

P: (231) 894-4590
 E: sales@spectrumillumination.com

SpectrumIllumination.com

E-Series Spot Lights

Features:

- Internal driver/controller included
- Auto Burst 3.5x Technology
- Thermal Protection to reduce downtime
- High Power LED's (24 VDC)
- Internal driver/controller
- M12 connector for quick disconnect
- Available in 5 colors, Ultra-Violet, and Infrared
- Available in 1 size and 40mm Spot Light
- 10 Year Warranty* - 50,000 hours

To Order, Specify;

1 Base Part Number

Example: **ES40** **WHI**
 \$325 **+ \$0**

2 Specify LED Color

1 Base Part Number	List Price	2 Specify LED Color
ES40 E-Series 40mm Spot Light With LED and 3 Meter Cable	\$325	365 + \$50 UV 365NM HB LED 395 + \$0 UV 395NM HB LED 470 + \$0 Blue 530 + \$0 Green 590 + \$0 Amber 630 + \$0 Red 850 + \$0 Infrared WHI + \$0 White
		
Standard Dimensions W 1.506" L 3.301" H 1.181" Wgt .5 lbs		

3 Specify Lens Type **4** Specify Diffuser Type **5** Specify Cable Option

23 **CC** **EC3**
 + \$0 **+ \$0** **+ \$0**

3 Specify Lens Type	4 Specify Diffuser Type	5 Specify Cable Option
16 + \$0 LED Optics 16 Frosted	CC + \$0 Clear Cover	EC3 + \$0 E-Series Cable 3M
23 + \$0 LED Optics 23 Frosted	SD + \$15 Standard Diffuser	EC5 + \$15 E-Series Cable 5M
39 + \$0 LED Optics 39 Frosted	TFD + \$15 Thin Film Diffuser	
R + \$0 LED Reflector 90	WD + \$15 White Diffuser	
R60 + \$0 LED Reflector 60	P + \$25 Polarizer	
L + \$0 LED Optics Line		

This page is intentionally blank



MACHINE VISION LIGHTING SINCE 1999



Spectrum Illumination's **Monster-Series Spot Lights** are designed for both bright field and dark field illumination. Spot lights are available for washdown applications.

Monster-Series Spot Lights



Units come with light, driver(s) / controller(s) and cable.

Series Highlights

- External driver/controller included
- HS (High Speed) Strobe Technology
- High Power LED's (24 VDC)
- DIN rail mount driver/controller
- M12 connector for quick disconnect
- Available in 8 colors, Ultra-Violet, and Infrared
- Available in 3 sizes
- 10 Year Warranty* - 100,000 hours

Units come with light, driver(s) / controller(s) and cable.

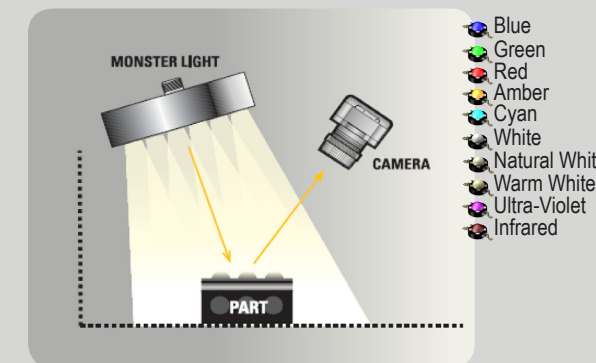

*10-Year warranty on registered products
 *6-Year warranty on non-registered products
 *3-year warranty on washdown lights
spectrumillumination.com/limited-warranty/

Application Examples

- Diffuse incident (front) lighting
- Food and Beverage
- High speed bottling and canning operations
- Inspection
- Measure translucency
- Pharmaceutical

P: (231) 894-4590
 E: sales@spectrumillumination.com

SpectrumIllumination.com

Monster-Series Spot Lights





Features:

- External driver/controller included
- HS (High Speed) Strobe Technology
- High Power LED's (24 VDC)
- DIN rail mount driver/controller
- M12 connector for quick disconnect
- Available in 8 colors, Ultra-Violet, and Infrared
- Available in 3 sizes
- 10 Year Warranty* - 100,000 hours

Caution –

The supplied LDM adapter must be used for both continuous or strobe operations! Do not connect the fixture directly to 24VDC! Operating the fixture without the supplied LDM adapter will result in premature LED failure and will void the warranty.

To Order, Specify;			
1 Base Part Number	Example:		
	MSP1.25	395	12
	\$350	+ \$0	+ \$0
2 Specify LED Color	3 Specify Lens Type		

1 Base Part Number	List Price	2 Specify LED Color	3 Specify Lens Type
MSP1.25 1.25" Spot Light LED - Package Includes Light, LDM 350/1, and 4 Meter Cable 	\$350	365 + \$50 UV 365NM HB LED	12 + \$0 12 Degree Optics
		395 + \$0 UV 395NM HB LED	16 + \$0 LED Optics 16 Frosted
		940 + \$0 Infrared	23 + \$0 LED Optics 23 Frosted
		470 + \$0 Blue	30 + \$0 30 Degree Frosted Optics
		505 + \$0 Cyan	39 + \$0 LED Optics 39 Frosted
		530 + \$0 Green	50 + \$0 50 Degree Optics
		590 + \$0 Amber	F + \$0 Wide Angle Optics
		630 + \$0 Red	R + \$0 LED Reflector 90
		850 + \$0 Infrared	R60 + \$0 LED Reflector 60
		WHI + \$0 White	L + \$0 LED Optics Line
		NWH + \$0 Natural White	
		WWH + \$0 Warm White	
MSP3.25 3.25" Spot Light LED's - Package Includes Light, LDM 350/3 (LDM 350/2 For Ir), and 4 Meter Cable 	\$600	365 + \$175 UV 365NM HB LED	12 + \$0 12 Degree Optics
		395 + \$0 UV 395NM HB LED	16 + \$0 LED Optics 16 Frosted
		470 + \$0 Blue	23 + \$0 LED Optics 23 Frosted
		505 + \$0 Cyan	30 + \$0 30 Degree Frosted Optics
		530 + \$0 Green	39 + \$0 LED Optics 39 Frosted
		590 + \$0 Amber	50 + \$0 50 Degree Optics
		630 + \$0 Red	F + \$0 Wide Angle Optics
		850 + \$0 Infrared	R + \$0 LED Reflector 90
		WHI + \$0 White	R60 + \$0 LED Reflector 60
			L + \$0 LED Optics Line

4 Specify Diffuser Option	5 Specify Cable Option	6 Specify Driver Option
SD + \$0	MC4 + \$0	A + \$85

4 Specify Diffuser Option	5 Specify Cable Option	6 Specify Driver Option
SD + \$0 Standard Diffuser	MC4 + \$0 Monster Cable 4 meter	LDM350/1 + \$0 350mA single LED Driver DIN rail mount
CC + \$25 Clear Cover	MC8 + \$40 Monster Cable 8 meter	A + \$85 ALDM Driver
TFD + \$25 Thin Film Diffuser	MC15 + \$60 Monster Cable 15 meter	V + \$85 VLDM Driver
WD + \$25 White Diffuser	MC30 + \$195 Monster Cable 30 meter	RV + \$100 RVLDM Driver
P + \$25 Polarizer	MCHF4 + \$75 Monster High Flex Cable 4 meter	
	MCHF8 + \$100 Monster High Flex Cable 8 meter	
	MCHF15 + \$200 Monster High Flex Cable 15 meter	
	MCHF30 + \$380 Monster High Flex Cable 30 meter	

SD + \$0 Standard Diffuser	MC4 + \$0 Monster Cable 4 meter	LDM350/3 + \$0 350mA 5-6 LED Driver DIN Rail Mount
CC + \$25 Clear Cover	MC8 + \$40 Monster Cable 8 meter	A + \$85 ALDM Driver
TFD + \$25 Thin Film Diffuser	MC15 + \$60 Monster Cable 15 meter	V + \$85 VLDM Driver
WD + \$25 White Diffuser	MC30 + \$195 Monster Cable 30 meter	RV + \$100 RVLDM Driver
P + \$25 Polarizer	MCHF4 + \$75 Monster High Flex Cable 4 meter	
	MCHF8 + \$100 Monster High Flex Cable 8 meter	
	MCHF15 + \$200 Monster High Flex Cable 15 meter	
	MCHF30 + \$380 Monster High Flex Cable 30 meter	

Back Lights
Diffused Axial
Dome Lights
Linear Lights
Oxy Lights
Ring Lights
Spot Lights
TriPod Lights
Washdown Lights
Controllers & Cables

Back Lights
Diffused Axial
Dome Lights
Linear Lights
Oxy Lights
Ring Lights
Spot Lights
TriPod Lights
Washdown Lights
Controllers & Cables

Monster-Series Spot Lights

Features:

- External driver/controller included
- HS (High Speed) Strobe Technology
- High Power LED's (24 VDC)
- DIN rail mount driver/controller
- M12 connector for quick disconnect
- Available in 8 colors, Ultra-Violet, and Infrared
- Available in 3 sizes
- 10 Year Warranty* - 100,000 hours

Caution –

The supplied LDM adapter must be used for both continuous or strobe operations! Do not connect the fixture directly to 24VDC! Operating the fixture without the supplied LDM adapter will result in premature LED failure and will void the warranty.

To Order, Specify;			
1 Base Part Number	Example:		
	MSP5.5	395	12
	\$1375	+ \$0	+ \$0
2 Specify LED Color	3 Specify Lens Type		

1 Base Part Number	List Price	2 Specify LED Color	3 Specify Lens Type	
MSP5.5 5.5" Spot Light LED's - Package Includes Light, LDM 1050, and 4 Meter Cable	\$1375	365 + \$450 UV 365NM HB LED	12 + \$0 12 Degree Optics	
		395 + \$0 UV 395NM HB LED	16 + \$0 LED Optics 16 Frosted	
		470 + \$0 Blue	23 + \$0 LED Optics 23 Frosted	
		505 + \$0 Cyan	30 + \$0 30 Degree Frosted Optics	
		530 + \$0 Green	39 + \$0 LED Optics 39 Frosted	
		590 + \$0 Amber	50 + \$0 50 Degree Optics	
		630 + \$0 Red	F + \$0 Wide Angle Optics	
		850 + \$0 Infrared	R + \$0 LED Reflector 90	
		WHI + \$0 White	R60 + \$0 LED Reflector 60	
			L + \$0 LED Optics Line	
		Standard Dimensions		
		Dia 6.75"		
		CC 21.195"		
		H 1.125"		
		Wgt 1.62 lbs		

4 Specify Diffuser Option	5 Specify Cable Option	6 Specify Driver Option
SD + \$0	MC4 + \$0	A + \$85

4 Specify Diffuser Option	5 Specify Cable Option	6 Specify Driver Option
SD + \$0 Standard Diffuser	MC4 + \$0 Monster Cable 4 meter	LDM1050 + \$0 1050mA LED Driver DIN rail mount
CC + \$25 Clear Cover	MC8 + \$40 Monster Cable 8 meter	A + \$85 ALDM Driver
TFD + \$25 Thin Film Diffuser	MC15 + \$60 Monster Cable 15 meter	V + \$85 VLDM Driver
WD + \$25 White Diffuser	MC30 + \$195 Monster Cable 30 meter	RV + \$100 RVLDM Driver
P + \$25 Polarizer	MCHF4 + \$75 Monster High Flex Cable 4 meter	
	MCHF8 + \$100 Monster High Flex Cable 8 meter	
	MCHF15 + \$200 Monster High Flex Cable 15 meter	
	MCHF30 + \$380 Monster High Flex Cable 30 meter	

This page is intentionally blank



MACHINE VISION LIGHTING SINCE 1999



Monster-Series Xtreme Spot Lights

Spectrum Illumination's **Monster-Series Xtreme Spot Lights** are designed for both bright field and dark field illumination. X-Series Spot lights have an aluminum circuit board and single interface housing to dissipate heat. X-Series Burst 3.5x capabilities are protected by thermal auto resetting circuit.



Units come with cable.

Series Highlights

- Internal driver/controller included
- Auto Burst 3.5x Technology
- Ultra-High Power LED's (24 VDC)
- Robot friendly weight
- M12 connector for quick disconnect
- PNP and NPN inputs
- Thermal Protection
- Available in 3 colors and Infrared
- Available in 3 sizes
- 10 Year Warranty* - 100,000 hours

Application Examples

- Automotive and aerospace processing
- Defects and surfaces
- Inspection
- Large surface inspection
- OCR
- Packaging
- Print control

Units come with cable.

• White
 • Natural White
 • Warm White
 • Infrared

*10-Year warranty on registered products
 *6-Year warranty on non-registered products
 *3-year warranty on washdown lights
 spectrumillumination/limited-warranty/

P: (231) 894-4590
E: sales@spectrumillumination.com

SpectrumIllumination.com

Monster-Series Xtreme Spot Lights

Features:

- Internal driver/controller included
- Auto Burst 3.5x Technology
- Ultra-High Power LED's (24 VDC)
- Robot friendly weight
- M12 connector for quick disconnect
- PNP and NPN inputs
- Thermal Protection
- Available in 3 colors and Infrared
- Available in 3 sizes
- 10 Year Warranty* - 100,000 hours

To Order, Specify;

① Base Part Number

Example:

XS40	WHI
\$350	+ \$0

② Specify LED Color

① Base Part Number	List Price	② Specify LED Color
XS40 Extreme Series 40mm Spot Light With LED and 3 Meter Cable 	\$350	850 + \$10 Infrared WHI + \$0 White NWH + \$0 Natural White WWH + \$0 Warm White
Standard Dimensions W 1.506" L 3.301" H 1.181" Wgt .5 lbs		

③ Specify Lens Type	④ Specify Diffuser Type	⑤ Specify Cable Option
23 + \$0	CC + \$0	EC3 + \$0

③ Specify Lens Type	④ Specify Diffuser Type	⑤ Specify Cable Option
23 + \$0 LED Optics 23	CC + \$0 Clear Cover	EC3 + \$0 E-Series Cable 3M
32 + \$0 LED Optics 32	SD + \$15 Standard Diffuser	EC5 + \$15 E-Series Cable 5M
56 + \$0 56 Degree Optics	TFD + \$15 Thin Film Diffuser	
	WD + \$15 White Diffuser	
	P + \$25 Polarizer	

TriPod Lights

Monster-Series TriPod Lights - Internal Driver Included 137-139



MACHINE VISION LIGHTING SINCE 1999



Spectrum Illumination's **Monster-Series TriPod Lights** are designed for bright field and dark field illumination. TriPod Lights have an aluminum circuit board and single interface housing to dissipate heat. TriPod Burst 2.4x capabilities.

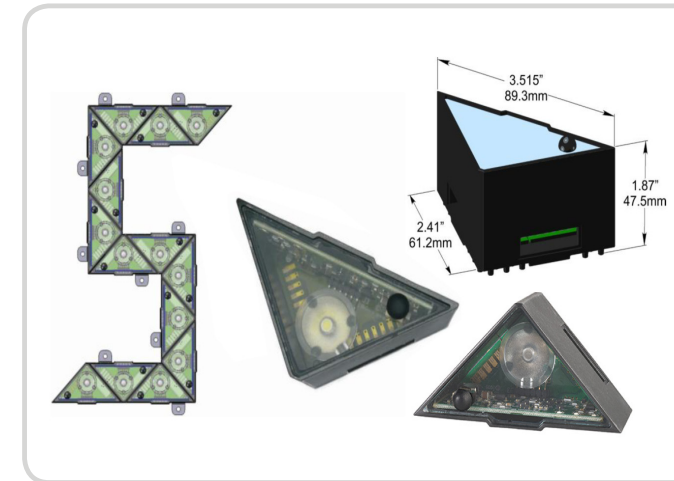

Units come with light assembly.

Series Highlights

- Internal driver/controller included
- Auto Burst 2.4x Technology
- High Power LED's (24 VDC)
- Reconfigurable design
- 6 pin screw main connector
- 7 pin stackable PCB edge connector
- Available in 4 colors
- 10 Year Warranty* - 50,000 hours

Units come with light assembly.

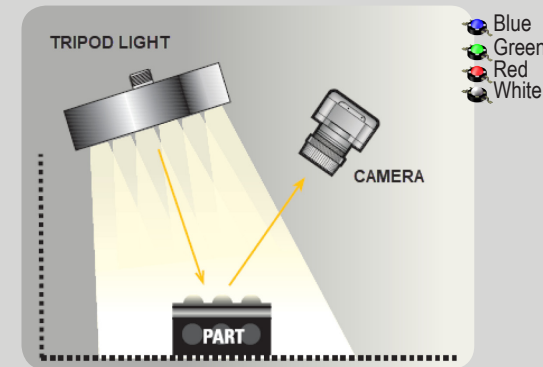

*10-Year warranty on registered products
 *6-Year warranty on non-registered products
 *3-year warranty on washdown lights
 spectrumillumination/limited-warranty/

Application Examples

- Automotive and aerospace processing
- Defects and surfaces
- Inspection
- Large surface inspection
- OCR
- Packaging
- Print control

P: (231) 894-4590
 E: sales@spectrumillumination.com

SpectrumIllumination.com

Monster-Series TriPod Lights

Features:

- Internal driver/controller included
- Auto Burst 2.4x Technology
- High Power LED's (24 VDC)
- Reconfigurable design
- 6 pin screw main connector
- 7 pin stackable PCB edge connector
- Available in 4 colors
- 10 Year Warranty* - 50,000 hours

To Order, Specify;	
① Base Part Number	
Example:	TP1 \$230
② Specify LED Color	470 + \$0

① Base Part Number	List Price	② Specify LED Color
TP1 Tripod Modular Light With LED - Single Unit	\$230	470 + \$0 Blue 530 + \$0 Green 630 + \$0 Red WHI + \$0 White

Standard Dimensions	
W	2.41"
L	3.515"
H	1.87"
Wgt	.17 lbs





Monster-Series TriPod Accessories

To Order, Specify;	
① Base Part Number	
Example:	TP1-CBR \$4

① Base Part Number	List Price
TP1-CBR Tripod Joining Bracket	\$4
	
TP1-MBR Tripod Mounting and Joining Bracket	\$10
	
TP1-MC Multiple Module Connector for Tripod Modular Light	\$16.50
	
TP-SC Male Screw Connector for Tripod Power and I/O	\$15
	

Washdown Lights

 Standard-Series Washdown Lights - No Driver Required	141-144
 Monster-Series Washdown Lights - External Driver Included	145-155

SPECTRUM ILLUMINATION

MACHINE VISION LIGHTING SINCE 1999

Standard-Series Washdown Lights



Spectrum Illumination's **Standard-Series Washdown Lights** are designed using FDA compliant delrin, 316 stainless steel, EPDM, Nitril or silicone rubber to meet FDA requirements. Used in the food industry and harsh environments where water and corrosive materials are present. Washdown lights are available in Ring and Back Lighting options.



Washdown lights are available in Ring and Back Lighting options.

Units come with light and cable.

Series Highlights

- No driver/controller required
- HS (High Speed) Strobe Technology
- 24 VDC
- M12 connector for quick disconnect
- IP68 and FDA Compliant
- Available in 4 colors and Infrared
- Available in 4 Back Light sizes and 1 Ring Light size
- 3 Year Warranty* - 100,000 hours

Application Examples

- Food and Beverage
- Harsh environment solutions
- High speed bottling and canning operations
- Inspections
- Measure translucency
- Pharmaceutical

Units come with light and cable.

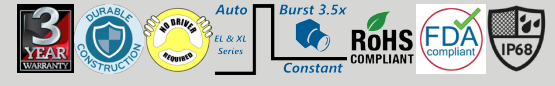
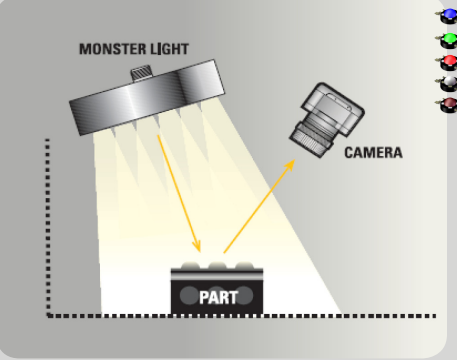
- Blue
- Green
- Red
- White
- Infrared

*10-Year warranty on registered products
 *6-Year warranty on non-registered products
 *3-year warranty on washdown lights
 spectrumillumination/limited-warranty/

P: (231) 894-4590
 E: sales@spectrumillumination.com

SpectrumIllumination.com

Standard-Series Washdown Lights

Features:

- No driver/controller required
- HS (High Speed) Strobe Technology
- 24 VDC
- M12 connector for quick disconnect
- IP68 and FDA Compliant
- Available in 4 colors and Infrared
- Available in 4 Back Light sizes and 1 Ring Light size
- 3 Year Warranty* - 100,000 hours

To Order, Specify;

1 Base Part Number	WBL28
Example:	\$1500
2 Specify LED Color	470 + \$100
3 Specify Diffuser Type	WD + \$0
4 Specify Cable Option	WSC4 + \$0

1 Base Part Number	List Price	2 LED Color	3 Diffuser Type	4 Cable Option
--------------------	------------	-------------	-----------------	----------------

WBL28 2" X 8" Back Light LED Wash Down - Package Includes Light, and 4 Meter Stainless Steel Cable	\$1500	470 + \$100 Blue 530 + \$100 Green 660 + \$0 Red 880 + \$0 Infrared WHI + \$100 White	WD + \$0 White Diffuser CC + \$50 Clear Cover SD + \$50 Standard Diffuser	WSC4 + \$0 Washdown Std Series Cable 4 meter WSC8 + \$60 Washdown Std Series Cable 8 meter WSC15 + \$80 Washdown Std Series Cable 15 meter WSC30 + \$150 Washdown Std Series Cable 30 meter
--	---------------	---	---	--



Standard Dimensions

W 4.25"

L 10.25"

H 2.25"

WBL44 4" X 4" Back Light LED Wash Down - Package Includes Light, and 4 Meter Stainless Steel Cable	\$1300	470 + \$100 Blue 530 + \$100 Green 660 + \$0 Red 880 + \$0 Infrared WHI + \$100 White	WD + \$0 White Diffuser CC + \$50 Clear Cover SD + \$50 Standard Diffuser	WSC4 + \$0 Washdown Std Series Cable 4 meter WSC8 + \$60 Washdown Std Series Cable 8 meter WSC15 + \$80 Washdown Std Series Cable 15 meter WSC30 + \$150 Washdown Std Series Cable 30 meter
--	---------------	---	---	--



Standard Dimensions

W 6.25"

L 6.25"

H 2.25"

Standard-Series Washdown Lights

Features:

- No driver/controller required
- HS (High Speed) Strobe Technology
- 24 VDC
- M12 connector for quick disconnect
- IP68 and FDA Compliant
- Available in 4 colors and Infrared
- Available in 4 Back Light sizes and 1 Ring Light size
- 3 Year Warranty* - 100,000 hours

To Order, Specify;

1 Base Part Number	WBL48
Example:	\$1700
2 Specify LED Color	660 + \$0
3 Specify Diffuser Type	WD + \$0
4 Specify Cable Option	WSC4 + \$0

1 Base Part Number	List Price	2 LED Color	3 Diffuser Type	4 Cable Option
--------------------	------------	-------------	-----------------	----------------

WBL48 4" X 8" Back Light LED Wash Down - Package Includes Light, and 4 Meter Stainless Steel Cable	\$1700	470 + \$200 Blue 660 + \$0 Red 880 + \$0 Infrared WHI + \$200 White	WD + \$0 White Diffuser CC + \$75 Clear Cover SD + \$75 Standard Diffuser	WSC4 + \$0 Washdown Std Series Cable 4 meter WSC8 + \$60 Washdown Std Series Cable 8 meter WSC15 + \$80 Washdown Std Series Cable 15 meter WSC30 + \$150 Washdown Std Series Cable 30 meter
--	---------------	--	---	--



Standard Dimensions

W 6.25"

L 10.25"

H 2.25"

Wgt 5.55 lbs

WBL812 8" X 12" Back Light LED Wash Down - Package Includes Light, and 4 Meter Stainless Steel Cable	\$2700	470 + \$700 Blue 660 + \$0 Red 880 + \$0 Infrared WHI + \$700 White	WD + \$0 White Diffuser CC + \$100 Clear Cover SD + \$100 Standard Diffuser	WSC4 + \$0 Washdown Std Series Cable 4 meter WSC8 + \$60 Washdown Std Series Cable 8 meter WSC15 + \$80 Washdown Std Series Cable 15 meter WSC30 + \$150 Washdown Std Series Cable 30 meter
--	---------------	--	---	--



Standard Dimensions

W 10.31"

L 14.31"

H 2.25"

Standard-Series Washdown Lights

Features:

- No driver/controller required
- HS (High Speed) Strobe Technology
- 24 VDC
- M12 connector for quick disconnect
- IP68 and FDA Compliant
- Available in 2 colors and Infrared
- Available in 4 Back Light sizes and 1 Ring Light size
- 3 Year Warranty* - 100,000 hours

To Order, Specify;

1 Base Part Number	WRL4
Example:	\$1250
2 Specify LED Color	660 + \$0
3 Specify Diffuser Type	SD + \$0
4 Specify Cable Option	WSC4 + \$0

1 Base Part Number	List Price	2 LED Color	3 Diffuser Type	4 Cable Option
WRL4 Wash Down 4" Ring Light LED - Package Includes Light and Stainless Steel 4 Meter Cord	\$1250	660 + \$0 Red	SD + \$0 Standard Diffuser	WSC4 + \$0 Washdown Std Series Cable 4 meter
		880 + \$0 Infrared	WD + \$25 White Diffuser	WSC8 + \$60 Washdown Std Series Cable 8 meter
		WHI + \$100 White	P + \$25 Polarizer	WSC15 + \$80 Washdown Std Series Cable 15 meter
				WSC30 + \$150 Washdown Std Series Cable 30 meter



Standard Dimensions

Dia	4.875"
CC	15.308"
H	1.312"
Wgt	1.7 lbs



MACHINE VISION LIGHTING SINCE 1999



Spectrum Illumination's **Monster-Series Washdown Lights** are designed using FDA compliant delrin, 316 stainless steel, EPDM, Nitril or silicone rubber to meet FDA requirements. Available in Linear and Spot Light.



Units come with light, driver(s) / controller(s) and cable.

Series Highlights

- External driver/controller included
- HS (High Speed) Strobe Technology
- High Power LED's (24 VDC)
- DIN rail mount driver/controller
- M12 connector for quick disconnect
- IP68 and FDA Compliant
- Available in 7 colors, Ultra-Violet, and Infrared
- Available in 4 sizes and 2 Spot Lights
- 3 Year Warranty* - 100,000 hours

Units come with light, driver(s) / controller(s) and cable.

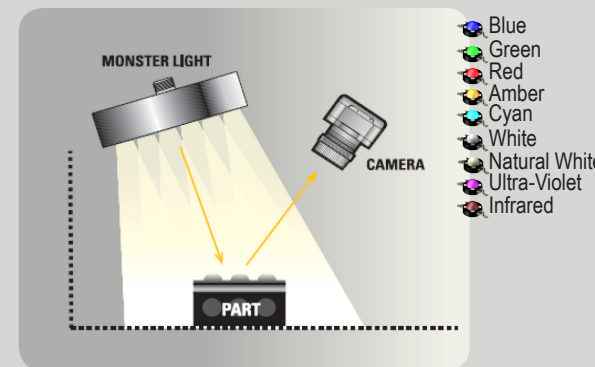

*10-Year warranty on registered products
 *6-Year warranty on non-registered products
 *3-year warranty on washdown lights
 spectrumillumination/limited-warranty/

P: (231) 894-4590
 E: sales@spectrumillumination.com

SpectrumIllumination.com

Monster-Series Washdown Lights

Features:



- External driver/controller included
- HS (High Speed) Strobe Technology
- High Power LED's (24 VDC)
- DIN rail mount driver/controller
- M12 connector for quick disconnect
- IP68 and FDA Compliant
- Available in 7 colors, Ultra-Violet, and Infrared
- Available in 4 sizes and 2 Spot Lights
- 3 Year Warranty* - 100,000 hours

Caution –

The supplied LDM adapter must be used for both continuous or strobe operations! Do not connect the fixture directly to 24VDC! Operating the fixture without the supplied LDM adapter will result in premature LED failure and will void the warranty.

To Order, Specify;

1 Base Part Number	Example:		
	WMLL16	395	12
	\$1000	+ \$0	+ \$0
2 Specify LED Color	3 Specify Lens Type		

1 Base Part Number	List Price	2 Specify LED Color	3 Specify Lens Type
WMLL16 Wash Down 6" Linear Light LED - Package Includes Light, LDM 350/3, and 4 Meter Stainless Steel Cable 	\$1000	365 + \$100 UV 365NM HB LED	12 + \$0 12 Degree Optics
		395 + \$0 UV 395NM HB LED	16 + \$0 LED Optics 16 Frosted
		470 + \$0 Blue	23 + \$0 LED Optics 23 Frosted
		505 + \$0 Cyan	30 + \$0 30 Degree Frosted Optics
		530 + \$0 Green	39 + \$0 LED Optics 39 Frosted
		590 + \$0 Amber	50 + \$0 50 Degree Optics
		630 + \$0 Red	F + \$0 Wide Angle Optics
		850 + \$0 Infrared	R + \$0 LED Reflector 90
		WHI + \$0 White	R60 + \$0 LED Reflector 60
WMLL111.5 Wash Down 11.5" Linear Light LED - Package Includes Light, LDM 700, and 4 Meter Stainless Steel Cable 	\$1450	365 + \$250 UV 365NM HB LED	12 + \$0 12 Degree Optics
		395 + \$0 UV 395NM HB LED	16 + \$0 LED Optics 16 Frosted
		470 + \$0 Blue	23 + \$0 LED Optics 23 Frosted
		505 + \$0 Cyan	30 + \$0 30 Degree Frosted Optics
		530 + \$0 Green	39 + \$0 LED Optics 39 Frosted
		590 + \$0 Amber	50 + \$0 50 Degree Optics
		630 + \$0 Red	F + \$0 Wide Angle Optics
		850 + \$0 Infrared	R + \$0 LED Reflector 90
		940 + \$0 Infrared	R60 + \$0 LED Reflector 60
		WHI + \$0 White	L + \$0 LED Optics Line
		NWH + \$0 Natural White	

4 Specify Diffuser Option	5 Specify Cable Option	6 Specify Driver Option
SD + \$0	WMC4 + \$0	A + \$85

4 Specify Diffuser Option	5 Specify Cable Option	6 Specify Driver Option
SD + \$0 Standard Diffuser	WMC4 + \$0 Washdown Monster Cable 4 meter	LDM350/3 + \$0 350mA 5-6 LED Driver DIN rail mount
CC + \$50 Clear Cover	WMC8 + \$55 Washdown Monster Cable 8 meter	A + \$85 ALDM Driver
WD + \$50 White Diffuser	WMC15 + \$75 Washdown Monster Cable 15 meter	V + \$85 VLDM Driver
	WMC30 + \$165 Washdown Monster Cable 30 meter	RV + \$100 RVLDM Driver

SD + \$0 Standard Diffuser	WMC4 + \$0 Washdown Monster Cable 4 meter	LDM700 + \$0 700mA LED Driver DIN rail mount
CC + \$75 Clear Cover	WMC8 + \$55 Washdown Monster Cable 8 meter	A + \$85 ALDM Driver
WD + \$75 White Diffuser	WMC15 + \$75 Washdown Monster Cable 15 meter	V + \$85 VLDM Driver
	WMC30 + \$165 Washdown Monster Cable 30 meter	RV + \$100 RVLDM Driver

Back Lights
Diffused Axial
Dome Lights
Linear Lights
Oxy Lights
Ring Lights
Spot Lights
TriPod Lights
Washdown Lights
Controllers & Cables

Back Lights
Diffused Axial
Dome Lights
Linear Lights
Oxy Lights
Ring Lights
Spot Lights
TriPod Lights
Washdown Lights
Controllers & Cables

Monster-Series Washdown Lights



Features:

- External driver/controller included
- HS (High Speed) Strobe Technology
- High Power LED's (24 VDC)
- DIN rail mount driver/controller
- M12 connector for quick disconnect
- IP68 and FDA Compliant
- Available in 7 colors, Ultra-Violet, and Infrared
- Available in 4 sizes and 2 Spot Lights
- 3 Year Warranty* - 100,000 hours

Caution –

The supplied LDM adapter must be used for both continuous or strobe operations! Do not connect the fixture directly to 24VDC! Operating the fixture without the supplied LDM adapter will result in premature LED failure and will void the warranty.

To Order, Specify;			
1 Base Part Number			
Example:	WMLL117.25	395	12
	\$2100	+ \$0	+ \$0
2 Specify LED Color	3 Specify Lens Type		

1 Base Part Number	List Price	2 Specify LED Color	3 Specify Lens Type		
WMLL117.25 Wash Down 17.25" Linear Light - Package Includes Light, LDM 1050 and 4 Meter Stainless Steel Cable  Standard Dimensions W 2.5" L 18.25" H 1.56"	\$2100	365 + \$350 UV 365NM HB LED	12 + \$0 12 Degree Optics		
		395 + \$0 UV 395NM HB LED	16 + \$0 LED Optics 16 Frosted		
		940 + \$0 Infrared	23 + \$0 LED Optics 23 Frosted		
		470 + \$0 Blue	30 + \$0 30 Degree Frosted Optics		
		505 + \$0 Cyan	39 + \$0 LED Optics 39 Frosted		
		530 + \$0 Green	50 + \$0 50 Degree Optics		
		590 + \$0 Amber	F + \$0 Wide Angle Optics		
		630 + \$0 Red	R + \$0 LED Reflector 90		
		850 + \$0 Infrared	R60 + \$0 LED Reflector 60		
		WHI + \$0 White	L + \$0 LED Optics Line		
		WMLL123 Wash Down 23" Linear Light LED - Package Includes Light, LDM 1400, and 4 Meter Stainless Steel Cable  Standard Dimensions W 2.5" L 24" H 1.625" Wgt 5.5 lbs	\$2300	365 + \$450 UV 365NM HB LED	12 + \$0 12 Degree Optics
				395 + \$0 UV 395NM HB LED	16 + \$0 LED Optics 16 Frosted
				940 + \$0 Infrared	23 + \$0 LED Optics 23 Frosted
				470 + \$0 Blue	30 + \$0 30 Degree Frosted Optics
				505 + \$0 Cyan	39 + \$0 LED Optics 39 Frosted
530 + \$0 Green	50 + \$0 50 Degree Optics				
590 + \$0 Amber	F + \$0 Wide Angle Optics				
630 + \$0 Red	R + \$0 LED Reflector 90				
850 + \$0 Infrared	R60 + \$0 LED Reflector 60				
WHI + \$0 White	L + \$0 LED Optics Line				
NWH + \$0 Natural White					

4 Specify Diffuser Option	5 Specify Cable Option	6 Specify Driver Option
SD + \$0	WMC4 + \$0	A + \$85

4 Specify Diffuser Option	5 Specify Cable Option	6 Specify Driver Option
SD + \$0 Standard Diffuser	WMC4 + \$0 Washdown Monster Cable 4 meter	LDM1050 + \$0 1050mA LED Driver DIN rail mount
CC + \$75 Clear Cover	WMC8 + \$55 Washdown Monster Cable 8 meter	A + \$85 ALDM Driver
WD + \$75 White Diffuser	WMC15 + \$75 Washdown Monster Cable 15 meter	V + \$85 VLDM Driver
	WMC30 + \$165 Washdown Monster Cable 30 meter	RV + \$100 RVLDM Driver

SD + \$0 Standard Diffuser	WMC4 + \$0 Washdown Monster Cable 4 meter	LDM1400 + \$0 1400mA LED Driver DIN rail mount
CC + \$75 Clear Cover	WMC8 + \$55 Washdown Monster Cable 8 meter	A + \$85 ALDM Driver
WD + \$75 White Diffuser	WMC15 + \$75 Washdown Monster Cable 15 meter	V + \$85 VLDM Driver
	WMC30 + \$165 Washdown Monster Cable 30 meter	RV + \$100 RVLDM Driver

Monster-Series Washdown Lights

Features:



- External driver/controller included
- HS (High Speed) Strobe Technology
- High Power LED's (24 VDC)
- DIN rail mount driver/controller
- M12 connector for quick disconnect
- IP68 and FDA Compliant
- Available in 7 colors, Ultra-Violet, and Infrared
- Available in 4 sizes and 2 Spot Lights
- 3 Year Warranty* - 100,000 hours

Caution –

The supplied LDM adapter must be used for both continuous or strobe operations! Do not connect the fixture directly to 24VDC! Operating the fixture without the supplied LDM adapter will result in premature LED failure and will void the warranty.

To Order, Specify;

1 Base Part Number	Example:	WMSP1.25	395	12
		\$525	+ \$75	+ \$0
2 Specify LED Color			3 Specify Lens Type	

1 Base Part Number	List Price	2 Specify LED Color	3 Specify Lens Type
WMSP1.25 Wash Down 1.25" Spot Light LED - Package Includes Light, LDM 350/1, and 4 Meter Cable  Standard Dimensions W 2.5" L 3.219" H 1.438" Wgt .9 lbs	\$525	365 + \$50 UV 365NM HB LED	12 + \$0 12 Degree Optics
		395 + \$0 UV 395NM HB LED	16 + \$0 LED Optics 16 Frosted
		470 + \$0 Blue	23 + \$0 LED Optics 23 Frosted
		505 + \$0 Cyan	30 + \$0 30 Degree Frosted Optics
		530 + \$0 Green	39 + \$0 LED Optics 39 Frosted
		590 + \$0 Amber	50 + \$0 50 Degree Optics
		630 + \$0 Red	F + \$0 Wide Angle Optics
		850 + \$0 Infrared	R + \$0 LED Reflector 90
		940 + \$0 Infrared	R60 + \$0 LED Reflector 60
		WHI + \$0 White	L + \$0 LED Optics Line
WMSP3.25 Wash Down 3.25" Spot Light LED - Package Includes Light, LDM 350/3, and 4 Me- ter Stainless Steel Cable  Standard Dimensions Dia 4.5" CC 14.13" H 1.25" Wgt 1.52 lbs	\$1000	365 + \$175 UV 365NM HB LED	12 + \$0 12 Degree Optics
		395 + \$0 UV 395NM HB LED	16 + \$0 LED Optics 16 Frosted
		940 + \$0 Infrared	23 + \$0 LED Optics 23 Frosted
		470 + \$0 Blue	30 + \$0 30 Degree Frosted Optics
		505 + \$0 Cyan	39 + \$0 LED Optics 39 Frosted
		530 + \$0 Green	50 + \$0 50 Degree Optics
		590 + \$0 Amber	F + \$0 Wide Angle Optics
		630 + \$0 Red	R + \$0 LED Reflector 90
		850 + \$0 Infrared	R60 + \$0 LED Reflector 60
		WHI + \$0 White	L + \$0 LED Optics Line

4 Specify Diffuser Option	5 Specify Cable Option	6 Specify Driver Option
SD + \$0	WMC4 + \$0	A + \$85

4 Specify Diffuser Option	5 Specify Cable Option	6 Specify Driver Option
SD + \$0 Standard Diffuser	WMC4 + \$0 Washdown Monster Cable 4 meter	LDM350/1 + \$0 350mA single LED Driver DIN rail mount
CC + \$25 Clear Cover	WMC8 + \$55 Washdown Monster Cable 8 meter	A + \$85 ALDM Driver
WD + \$25 White Diffuser	WMC15 + \$75 Washdown Monster Cable 15 meter	V + \$85 VLDM Driver
	WMC30 + \$165 Washdown Monster Cable 30 meter	RV + \$100 RVLDM Driver

SD + \$0 Standard Diffuser	WMC4 + \$0 Washdown Monster Cable 4 meter	LDM350/3 + \$0 350mA 5-6 LED Driver DIN Rail Mount
CC + \$50 Clear Cover	WMC8 + \$55 Washdown Monster Cable 8 meter	A + \$85 ALDM Driver
WD + \$50 White Diffuser	WMC15 + \$75 Washdown Monster Cable 15 meter	V + \$85 VLDM Driver
	WMC30 + \$165 Washdown Monster Cable 30 meter	RV + \$100 RVLDM Driver



MACHINE VISION LIGHTING SINCE 1999

Monster-Series Washdown Light



Spectrum Illumination's Monster-Series Washdown Lights are designed using FDA compliant materials, 316 stainless steel, EPDM, Nitril or silicone rubber to meet FDA requirements. Designed bright field applications that require a large area of coverage and/or long work distance. Washdown ring lights are designed for harsh environments. *Units come with light, driver(s) / controller(s) and cable.*

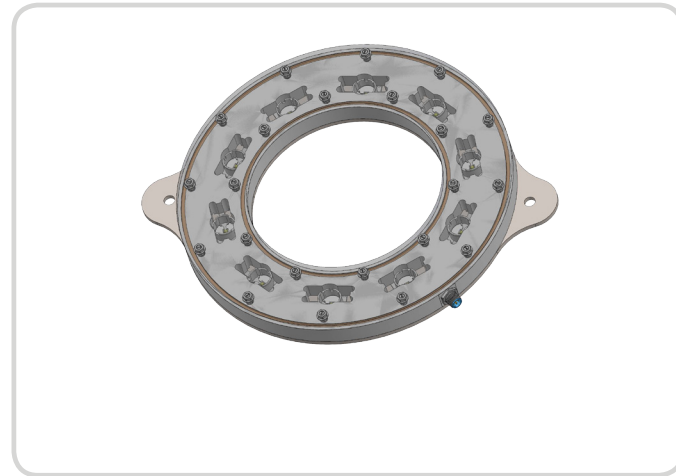

Series Highlights

- External driver/controller included
- HS (High Speed) Strobe Technology
- High Power LED's (24 VDC)
- M12 connector for quick disconnect
- Available in 6 colors and Infrared
- IP68 and FDA Compliant
- Available in 1 size - 8.5 inch
- 3 Year Warranty* – 100,000 hours

Application Examples

- Food and Beverage processing
- Harsh environment solutions
- Defects on surfaces
- Inspection
- Packaging
- Pharmaceutical
- High speed bottling & canning operations

Units come with light, driver(s) / controller(s) and cable.

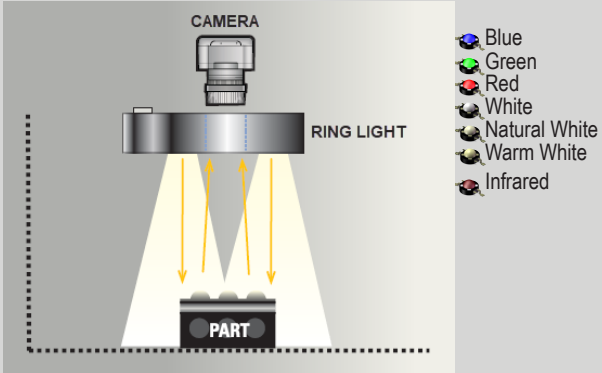

*10-Year warranty on registered products
 *6-Year warranty on non-registered products
 *3-year warranty on washdown lights
 spectrumillumination/limited-warranty/

P: (231) 894-4590
 E: sales@spectrumillumination.com

SpectrumIllumination.com



MACHINE VISION LIGHTING SINCE 1999

Monster-Series Washdown Dome Light



Spectrum Illumination's Monster-Series Washdown Dome Lights are designed using FDA compliant materials, 316 stainless steel, EPDM, Nitril or silicone rubber to meet FDA requirements. Dome lights eliminate hotspots and shadows creating even lighting on shiny or uneven surfaces. Washdown Dome light is designed for harsh environment applications. *Units come with light, driver(s) / controller(s) and cable.*

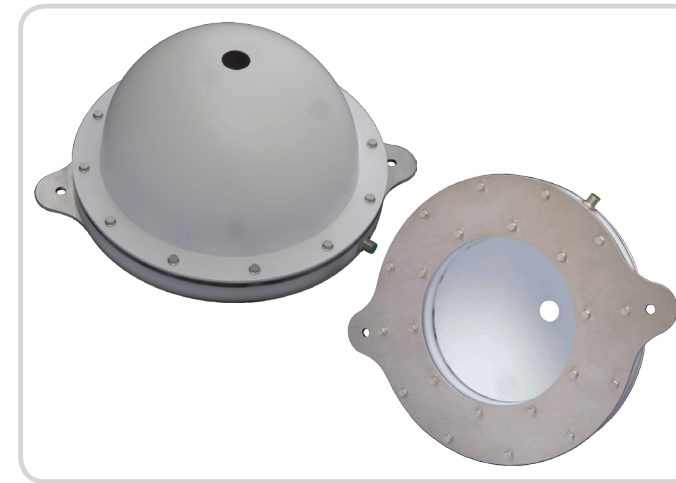

Units come with light, driver(s) / controller(s) and cable.

Series Highlights

- External driver/controller included
- HS (High Speed) Strobe Technology
- High Power LED's (24 VDC)
- M12 connector for quick disconnect
- Available in 6 colors and Infrared
- IP68 and FDA Compliant
- Self draining dome design
- Available in 1 size - 7 inch
- 3 Year Warranty* – 100,000 hours

Application Examples

- Food and Beverage processing
- Harsh environment solutions
- Defects on surfaces
- Inspection
- Packaging
- Pharmaceutical
- High speed bottling & canning operations

Units come with light, driver(s) / controller(s) and cable.

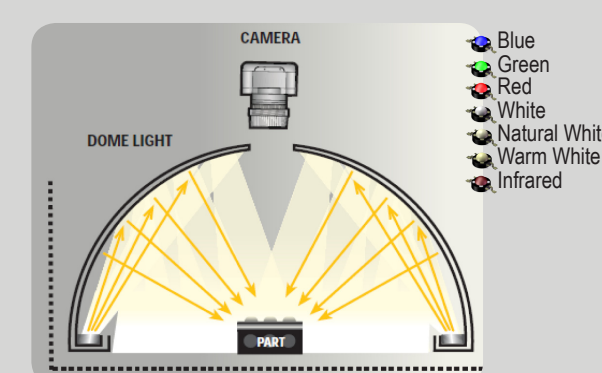

*10-Year warranty on registered products
 *6-Year warranty on non-registered products
 *3-year warranty on washdown lights
 spectrumillumination/limited-warranty/

P: (231) 894-4590
 E: sales@spectrumillumination.com

SpectrumIllumination.com

Monster-Series Washdown Ring & Dome Lights

Features:

- External driver/controller included
- HS (High Speed) Strobe Technology
- High Power LED's (24 VDC)
- M12 connector for quick disconnect
- Available in 8 colors and Infrared
- Available in 1 size
- IP68 & FDA Compliant
- Self draining dome design
- 3 Year Warranty* - 100,000 hours

To Order, Specify;

① Base Part Number

Example: **WMRL8.5 470 12**
\$2800 + \$0 + \$0

② Specify LED Color ③ Specify Lens Type

Caution –

The supplied LDM adapter must be used for both continuous or strobe operations! Do not connect the fixture directly to 24VDC! Operating the fixture without the supplied LDM adapter will result in premature

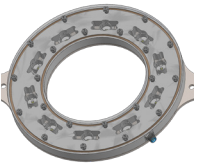
① Base Part Number	List Price	② Specify LED Color	③ Specify Lens Type
WMRL8.5 8.5" Ring Light LED - Package Includes Light, LDM 700, and 4 Meter Cable 	\$2800	470 + \$0 Blue	16 + \$0 LED Optics 16 Frosted
		505 + \$0 Cyan	23 + \$0 LED Optics 23 Frosted
		530 + \$0 Green	39 + \$0 LED Optics 39 Frosted
		590 + \$0 Amber	
		630 + \$0 Red	
		850 + \$0 Infrared	
		WHI + \$0 White	
		NWH + \$0 Natural White	
		WWH + \$0 Warm White	
		Standard Dimensions	
Dia 12"			
CC 37.68"			
H 1.45"			
Wgt 6.85 lbs			

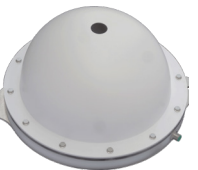
WMDL7 7" Dome Light LED - Package Includes Light, LDM 700 and 4 Meter Cable 	\$3000	470 + \$0 Blue	
		505 + \$0 Cyan	
		530 + \$0 Green	
		590 + \$0 Amber	
		630 + \$0 Red	
		850 + \$0 Infrared	
		WHI + \$0 White	
		NWH + \$0 Natural White	
		WWH + \$0 Warm White	
		Standard Dimensions	
Dia 12"			
CC 37.68"			
H 1.82"			
Wgt 7.90 lbs			

④ Specify Diffuser Option ⑤ Specify Cable Option ⑥ Specify Driver Option

CC + \$0 **WMC4 + \$0** **A + \$85**
 Clear Cover Washdown Monster Cable 4 meter 700mA LED Driver DIN rail mount

④ Specify Diffuser Option	⑤ Specify Cable Option	⑥ Specify Driver Option
CC + \$0 Clear Cover	WMC4 + \$0 Washdown Monster Cable 4 meter	LDM700 + \$0 700mA LED Driver DIN rail mount
WD + \$50 White Diffuser	WMC8 + \$55 Washdown Monster Cable 8 meter	A + \$85 ALDM Driver
	WMC15 + \$75 Washdown Monster Cable 15 meter	V + \$85 VLDM Driver
	WMC30 + \$165 Washdown Monster Cable 30 meter	RV + \$100 RVLDM Driver

	WMC4 + \$0 Washdown Monster Cable 4 meter	LDM700 + \$0 700mA LED Driver DIN rail mount
	WMC8 + \$55 Washdown Monster Cable 8 meter	A + \$85 ALDM Driver
	WMC15 + \$75 Washdown Monster Cable 15 meter	V + \$85 VLDM Driver
	WMC30 + \$165 Washdown Monster Cable 30 meter	RV + \$100 RVLDM Driver

Back Lights
Diffused Axial
Dome Lights
Linear Lights
Oxy Lights
Ring Lights
Spot Lights
TriPod Lights
Washdown Lights
Controllers & Cables

Back Lights
Diffused Axial
Dome Lights
Linear Lights
Oxy Lights
Ring Lights
Spot Lights
TriPod Lights
Washdown Lights
Controllers & Cables

Service Parts

Controllers/Drivers	157-162
Cables	163-165



MACHINE VISION LIGHTING SINCE 1999



LDM, VLDM, ALDM, RVLDM & MBC Ethernet Controller “Monster Brain Controller” : Spectrum Illumination’s drivers/controllers were designed to support High Power LED’s (24 VDC).



vvMBC controls strobe response, continuous operation, pulse, pulse delay, intensity and duration.MBC has up to 4 strobe channels and multiple driver modules can be connected on each channel. It can be configured for 1 strobe and 3 analog (0 – 10 volts).

Units come with 2 bus connectors.

Series Highlights

- Windows 10 compatible - MBC
- Apple IOS 11 compatible - MBC
- Wireless capability - MBC
- Ethernet capability - MBC
- Embedded web server - MBC
- Programmable false trigger blocking - MBC
- DIN rail mountable with bus connections - All
- PNP/NPN strobe inputs - All
- High Speed strobe technology
- 10 Year Warranty*

Application Examples

- LDM - LED Driver Module
- VLDM - Variable LED Driver Module
- RVLDM - Remote Variable LED Driver Module
- ALDM - Analog LED Driver Module
- MBC - Monster Brain Controller - Ethernet & Wireless Controller for LDM, VLDM & ALDM

Units come with 2 bus connectors.



- *10-Year warranty on registered products
- *6-Year warranty on non-registered products
- *3-year warranty on washdown lights
- spectrumillumination/limited-warranty/

P: (231) 894-4590
E: sales@spectrumillumination.com

SpectrumIllumination.com

LDM Series Controllers/Drivers

The LED Driver Module (LDM) is a current regulating DIN rail mounted adapter for our Monster Light Series products. Every Monster Light includes the correct LDM and 4 meter cable for the product. The LDM connects to industry standard 24VDC power and is used for strobe or continuous operation. The LDM Adapter has both PNP and NPN strobe inputs with a 3 microsecond response time. The strobe inputs are pulse width duration so they are on for the length of the supplied pulse. The LDM can also be connected to our Monster Brain Controller so the end user can control the number of pulses, pulse delay and pulse duration. The LDM adapter connects to the Monster Brain Controller with a DIN rail bus connector so that connections are effortless. Since the LDM's release in 2002 through today and after 8 revision improvements, the LDM has proven itself to be superior in reliability, repeatability and quality.

To Order, Specify;

① Base Part Number

Example:

LDM350/1
\$215

① Base Part Number	Description	List Price
LDM350/1	Standard LED Driver Module	\$215
LDM350/2	Standard LED Driver Module	\$215
LDM350/3	Standard LED Driver Module	\$215
LDM700	Standard LED Driver Module	\$215
LDM1050	Standard LED Driver Module	\$215
LDM1400	Standard LED Driver Module	\$215
LDM1750	Standard LED Driver Module	\$215
LDM2100	Standard LED Driver Module	\$215
LDM2800	Standard LED Driver Module	\$215
LDM3500	Standard LED Driver Module	\$215
LDM4900	Standard LED Driver Module	\$215



Standard Dimensions
W .89"
L 4.508"
H 3.898"
Wt .25lbs

ALDM Series Controllers/Drivers

The Analog LED Driver Module (ALDM) is a current regulating DIN rail mounted adapter for our Monster Light Series products. Unlike the LDM the ALDM also has a 0-10VDC input for intensity control. Every Monster Light can be ordered with the optional ALDM Adapter for a minimal up charge. The ALDM connects to industry standard 24VDC power and is used for strobe or continuous operation. The ALDM Adapter has both PNP and NPN strobe inputs with a 3 microsecond response time. The strobe inputs are pulse width duration so they are on for the length of the supplied pulse. The ALDM can also be connected to our Monster Brain Controller (MBC) so the end user can control the number of pulses, pulse delay, pulse duration and intensity. The ALDM adapter connects to the Monster Brain Controller with a DIN rail bus connector so that connections are effortless. The ALDM is based on the same time tested technology as our LDM Adapter.

To Order, Specify;

① Base Part Number

Example:

ALDM350/1
\$300

① Base Part Number	Description	List Price
ALDM350/1	0-10VDC intensity control DIN rail mounted Analog LED Driver Module	\$300
ALDM350/2	0-10VDC intensity control DIN rail mounted Analog LED Driver Module	\$300
ALDM350/3	0-10VDC intensity control DIN rail mounted Analog LED Driver Module	\$300
ALDM700	0-10VDC intensity control DIN rail mounted Analog LED Driver Module	\$300
ALDM1050	0-10VDC intensity control DIN rail mounted Analog LED Driver Module	\$300
ALDM1400	0-10VDC intensity control DIN rail mounted Analog LED Driver Module	\$300
ALDM1750	0-10VDC intensity control DIN rail mounted Analog LED Driver Module	\$300
ALDM2100	0-10VDC intensity control DIN rail mounted Analog LED Driver Module	\$300
ALDM2800	0-10VDC intensity control DIN rail mounted Analog LED Driver Module	\$300
ALDM3500	0-10VDC intensity control DIN rail mounted Analog LED Driver Module	\$300



Standard Dimensions
W 1.9"
D 2.1"
H .85"
Wt .25lbs

Back Lights
 Diffused Axial
 Dome Lights
 Linear Lights
 Oxy Lights
 Ring Lights
 Spot Lights
 TriPod Lights
 Washdown Lights
 Controllers & Cables

Back Lights
 Diffused Axial
 Dome Lights
 Linear Lights
 Oxy Lights
 Ring Lights
 Spot Lights
 TriPod Lights
 Washdown Lights
 Controllers & Cables

VLDM Series Controllers/Drivers

The Variable LED Driver Module (VLDM) is a current regulating DIN rail mounted adapter for our Monster Light Series products. Unlike the LDM the VLDM gives the end user the ability to adjust the light intensity via manual potentiometer. Every Monster Light can be ordered with the optional VLDM Adapter for a minimal up charge. The VLDM connects to industry standard 24VDC power and is used for strobe or continuous operation. The VLDM Adapter has both PNP and NPN strobe inputs with a 3 microsecond response time. The strobe inputs are pulse width duration so they are on for the length of the supplied pulse. The VLDM can also be connected to our Monster Brain Controller (MBC) so the end user can control the number of pulses, pulse delay and pulse duration. The VLDM adapter connects to the Monster Brain Controller with a DIN rail bus connector so that connections are effortless. The VLDM is based on the same time tested technology as our LDM Adapter.

To Order, Specify;

① Base Part Number

Example:

VLDM350/1
\$300

① Base Part Number	Description	List Price
VLDM350/1	DIN rail mounted Variable Intensity Control LED Driver Module	\$300
VLDM350/2	DIN rail mounted Variable Intensity Control LED Driver Module	\$300
VLDM350/3	DIN rail mounted Variable Intensity Control LED Driver Module	\$300
VLDM700	DIN rail mounted Variable Intensity Control LED Driver Module	\$300
VLDM1050	DIN rail mounted Variable Intensity Control LED Driver Module	\$300
VLDM1400	DIN rail mounted Variable Intensity Control LED Driver Module	\$300
VLDM1750	DIN rail mounted Variable Intensity Control LED Driver Module	\$300
VLDM2100	DIN rail mounted Variable Intensity Control LED Driver Module	\$300
VLDM2800	DIN rail mounted Variable Intensity Control LED Driver Module	\$300
VLDM3500	DIN rail mounted Variable Intensity Control LED Driver Module	\$300



Standard Dimensions
W .89"
L 4.508"
H 3.898"
Wt .25lbs

RLDM Series Controllers/Drivers

The Remote Variable LED Driver Module (RVLDM) is a current regulating DIN rail mounted adapter for our Monster Light Series products. Unlike the LDM the RVLDM gives the end user the ability to adjust the light intensity via manual remote potentiometer. Every Monster Light can be ordered with the optional RVLDM Adapter for a minimal up charge. The RVLDM connects to industry standard 24VDC power and is used for strobe or continuous operation. The RVLDM Adapter has both PNP and NPN strobe inputs with a 3 microsecond response time. The strobe inputs are pulse width duration so they are on for the length of the supplied pulse. The RVLDM can also be connected to our Monster Brain Controller (MBC) so the end user can control the number of pulses, pulse delay and pulse duration. The RVLDM adapter connects to the Monster Brain Controller with a DIN rail bus connector so that connections are effortless. The RVLDM is based on the same time tested technology as our LDM.

To Order, Specify;

① Base Part Number

Example:

RVLDM350/1
\$315

① Base Part Number	Description	List Price
RVLDM350/1	DIN rail mounted Remote Variable Intensity Control LED Driver Module	\$315
RVLDM350/2	DIN rail mounted Remote Variable Intensity Control LED Driver Module	\$315
RVLDM350/3	DIN rail mounted Remote Variable Intensity Control LED Driver Module	\$315
RVLDM700	DIN rail mounted Remote Variable Intensity Control LED Driver Module	\$315
RVLDM1050	DIN rail mounted Remote Variable Intensity Control LED Driver Module	\$315
RVLDM1400	DIN rail mounted Remote Variable Intensity Control LED Driver Module	\$315
RVLDM1750	DIN rail mounted Remote Variable Intensity Control LED Driver Module	\$315
RVLDM2100	DIN rail mounted Remote Variable Intensity Control LED Driver Module	\$315
RVLDM2800	DIN rail mounted Remote Variable Intensity Control LED Driver Module	\$315
RVLDM3500	DIN rail mounted Remote Variable Intensity Control LED Driver Module	\$315



Standard Dimensions
W 1.9"
D 2.1"
H .85"
Wt .25lbs

Back Lights
 Diffused Axial
 Dome Lights
 Linear Lights
 Oxy Lights
 Ring Lights
 Spot Lights
 TriPod Lights
 Washdown Lights
 Controllers & Cables

Back Lights
 Diffused Axial
 Dome Lights
 Linear Lights
 Oxy Lights
 Ring Lights
 Spot Lights
 TriPod Lights
 Washdown Lights
 Controllers & Cables

MBC Series Controllers/Drivers

To Order, Specify;

① Base Part Number

Example:

MBC-1
\$650

① Base Part Number	Description	List Price
MBC-1	Monster Brain Ethernet Controller	\$650



Standard Dimensions
W 1.78"
L 4.508"
H 3.898"
Wt .25lbs

The Monster Brain is an Ethernet controller that was designed to control our LDM, VLDM and ALDM Adapters. Every Adapter (Revision H and up) was designed to connect to the Monster Brain through a DIN rail bus connector in the back of the unit. The Monster Brain was designed with an embedded web server so that software is not necessary. The end user only needs to connect an Ethernet cable, open their internet browser, type in the IP address and the programming interface window opens. The Monster Brain can be used as a standalone unit or can be connected to a network. The Monster Brain gives the end user the ability to program up to 63 different product ID's (0-62) and recall them either through simple ASCII commands or hardwired binary inputs. Product ID number 63 is reserved for a function that loops through all of the products making it possible to have multiple timing and intensity levels of each channel with only one trigger signal input. The end user also has the flexibility to change any parameters on the Monster Brain using simple ASCII command strings. Flexibility was foremost in our minds when designing the Monster Brain. We designed it so the end user has 4 separate user configurable channels that can have multiple LDM, VLDM or ALDM modules on each channel. The channels can be configured as 4 strobe and 0 analog, 3 strobe and 1 analog, 2 strobe and 2 analog or 1 strobe and 3 analog. The four different channels give the end user the ability to set the number of pulses, pulse duration, pulse delays and current outputs. The Monster Brain also has 2 camera strobe outputs. The 2 camera strobe outputs are designed for applications that require the light to be at full intensity before acquiring an image. The Monster Brain is the most compact and versatile LED lighting controller in the Machine Vision Lighting Market.

Cables

To Order, Specify;

① Base Part Number

Example:

MC4
\$40

① Base Part Number	Description	List Price	
EC3	Standard Regular 3 Meter	\$40	.6lbs
EC5	Standard Regular 5 Meter	\$55	1.03lbs
MC4	Monster Regular 4 Meter	\$40	.5lbs
MC8	Monster Regular 8 Meter	\$80	.93lbs
MC15	Monster Regular 15 Meter	\$100	1.75lbs
MC30	Monster Regular 30 Meter	\$235	3.43lbs
MCHF4	Monster High Flex 4 Meter	\$115	.37lbs
MCHF8	Monster High Flex 8 Meter	\$140	.73lbs
MCHF15	Monster High Flex 15 Meter	\$240	1.34lbs
MCHF30	Monster High Flex 30 Meter	\$420	1.34lbs
SC4	Standard Regular 4 Meter	\$40	.35lbs
SC8	Standard Regular 8 Meter	\$90	.79lbs
SC15	Standard Regular 15 Meter	\$110	1.23lbs
SC30	Standard Regular 30 Meter	\$150	2.6lbs
SCHF4	Standard High Flex 4 Meter	\$115	.37lbs
SCHF8	Standard High Flex 8 Meter	\$140	.73lbs
SCHF15	Standard High Flex 15 Meter	\$190	1.34lbs
WMC4	Monster Wash Down 4 Meter	\$40	.48lbs
WMC8	Monster Wash Down 8 Meter	\$95	.92lbs
WMC15	Monster Wash Down 15 Meter	\$115	1.7lbs
WMC30	Monster Wash Down 30 Meter	\$205	3.2lbs
WSC4	Standard Wash Down 4 Meter	\$40	.35lbs
WSC8	Standard Wash Down 8 Meter	\$100	.77lbs
WSC15	Standard Wash Down 15 Meter	\$120	1.39lbs
WSC30	Standard Wash Down 30 Meter	\$190	1.39lbs

Back Lights
 Diffused Axial
 Dome Lights
 Linear Lights
 Oxy Lights
 Ring Lights
 Spot Lights
 TriPod Lights
 Washdown Lights
 Controllers & Cables

Back Lights
 Diffused Axial
 Dome Lights
 Linear Lights
 Oxy Lights
 Ring Lights
 Spot Lights
 TriPod Lights
 Washdown Lights
 Controllers & Cables

Cables for Monster Linear Lights 69” and 80.5”

To Order, Specify;

① Base Part Number

Example:

MC4-HO/6
\$150

① Base Part Number	Description	List Price
MC4-HO/6	Monster Cable High Output 4 meter	\$150
MC8-HO/6	Monster Cable High Output 8 meter	\$225
MC15-HO/6	Monster Cable High Output 15 meter	\$275
MC30-HO/6	Monster Cable High Output 30 meter	*Call for pricing
MCHF4-HO/6	Monster High Flex High Output 4 meter cable	*Call for pricing
MCHF8-HO/6	Monster High Flex High Output 8 meter cable	*Call for pricing
MCHF15-HO/6	Monster High Flex High Output 15 meter cable	*Call for pricing
MCHF30-HO/6	Monster High Flex High Output 30 meter cable	*Call for pricing

Back Lights
Diffused Axial
Dome Lights
Linear Lights
Oxy Lights
Ring Lights
Spot Lights
TriPod Lights
Washdown Lights
Controllers & Cables

Spectrum Color Box Test Light Multicolor Tool

Spectrum Color Box is an important tool for testing the different colors that work best on your vision application.

Perfect for field testing on a vision application or use in a Vision Lab. Easy to use just push the button for the desired color. Spectrum Color Box works with standard CCD or CMOS cameras.

Materials respond to color in different ways. Oftentimes the only way to know the color or wavelength that works the best is by testing different color lights. Purchasing each color LED light can be a large investment. The “Spectrum Color Box” is a smaller investment vs. buying 6 different colors of LED lights.

Product Details

- 6 High Power LED's – White 6-7K, Red 630nm, Blue 470nm, Green 530nm, UV 395nm & IR 850nm
- Push button testing for LED on/off
- 3 AA Extended Life batteries pre-installed
- 10 Year Warranty

Part Number: ML-demo/c

List Price: \$375.00



- Blue
- Green
- Red
- White
- Ultra-Violet
- Infrared

This page is intentionally blank

LIMITED WARRANTY

Every Spectrum Illumination, Inc. product is thoroughly inspected and tested before leaving the factory. Standard products purchased on or after September 1, 2013 (**excluding wash down light heads**) are warranted to be free of defects in workmanship and materials for a period of **10 Years* (upon registration)** from the original date of purchase. Non-registered products default to **6 Years**. Should a defect develop during this period, return the complete product, freight prepaid, to one of Spectrum Illumination's distributors. The distributor will need to call for an RMA for repair before returning the product to Spectrum Illumination, Inc. Spectrum Illumination, Inc. will inspect the unit, and if a defect is found will, at our option, repair or replace the product without charge. Spectrum Illumination, Inc. disclaims liability for any implied warranties, including implied warranties of "merchantability" and "fitness for a specific purpose." **Register your warranty www.spectrumillumination.com/warranty-registration/.**

Washdown light heads and standard products purchased before September 1, 2013 are covered for a period of **3 Years** from the original date of purchase. Wash down light heads are enclosed in stainless steel enclosures that do not dissipate heat away from the LED's as well as standard products. All requirements for return are stipulated in the previous paragraph. **Register your warranty www.spectrumillumination.com/warranty-registration/.**

Spectrum Illumination, Inc. cannot be held responsible for the unauthorized or inappropriate use of our products. Products that include a driver will not be covered under this warranty if the driver was not used. Spectrum Illumination, Inc. will not cover products that have been determined to have run on third party strobe or LED controllers. **Register your warranty www.spectrumillumination.com/warranty-registration/.**

NO LIABILITY FOR CONSEQUENTIAL DAMAGES.

In no event shall Spectrum Illumination, Inc. be liable for consequential, special, incidental, extra cost, expenses, losses, loss of profits or indirect damages of any kind arising from the sale or use of products.

This warranty supersedes all previously printed Spectrum Illumination warranties.

10 Year Registered Products	6 Year Non - Registered Products	3 Year
Back lights	Back lights	Washdown Lights
Diffused Axial	Diffused Axial	
Dome Lights	Dome Lights	
Linear Lights	Linear Lights	
Oxy Lights	Oxy Lights	
Ring Lights	Ring Lights	
Spot Lights	Spot Lights	
Tri-Pod Lights	Tri-Pod Lights	
Controllers	Controllers	

5114 Industrial Park Road, Montague, MI 49437 Phone: 231-894-4590 www.spectrumillumination.com

*10-Year warranty on registered products, 6-Year on non-registered products and 3-year on washdown lights.

Register your warranty www.spectrumillumination.com/warranty-registration/

APPLICATION:

Due to the increasing LED output, we recommend a maximum duty cycle of 10%. Polarizing film blocks or absorbs about 61% of the energy emitted by LED's and can cause damage to the polarizer. Warranty does not apply to polarizers due to increased LED output.

MECHANICAL:

Thickness: 0.19mm (0.0075")

Direction: Linear

Durability:

Heat Resistance: (115°C x 240h) (105°C x 1000h)

Humidity Resistance: (85°C x 85%RH x 240h) (80°C x 90%RH x 500h)

Heat Shock: (-40°C x 1h) ↔ (85°C x 1h) x 20 cycles

Low Temperature Resistance: (-40°C x 1000h)

Deterioration of Transmittance (Δ Ys): ± 5 points from initial value,

Polarizing Efficiency (Δ Py): ± 2 points from initial value.

OPTICAL:

Single Average Transmittance: 39 ± 2%

Polarizing efficiency: >99.9%

Hue

L* (L) 68.0 ± 2.0 (61.6 ± 2.0)

a* (a) -1.4 ± 2.0 (-1.2 ± 2.0)

b* (b) 5.0 ± 2.0 (4.3 ± 2.0)

Wavelength: 400~700nm

Contrast Ratio: 10,000:1 average

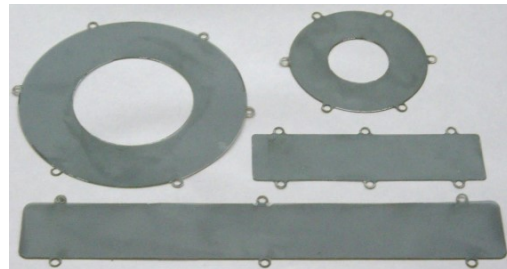

PART NUMBER DESIGNATION:

P-XXXXX to order as separate item

XXXXX-YYY/P to order with the light (Ships as separate line item)

XXXXX = Light Part Number

YYY = Light Color

/P adds polarizer

Example: P-SP3.25 Polarizer for Spot Light, 3.25"

MSP3.25-WHI/P Spot Light, 3.25", White, shipped with polarizer

Spectrum Illumination • 5114 Industrial Park Rd. • Montague, MI 49437

Phone 231-894-4590 Fax 231-894-4582

www.spectrumillumination.com

Rev. Date: 2018-08-13

MECHANICAL:

20mm optic

Lens Quality Polycarbonate

High thermal stability

OPTICAL:

Part No	Lense Option	Description	FWHM#	EFF
ML-12	/12	Plain tight beam optic	12.8°	86.2%
ML-30	/30	Ripple medium beam optic	25.7°	83.7%
ML-50	/50	Ripple medium beam optic	38.8°	79.1%
ML-L	/L	Line Optic	44.1° x 15.3°	82.5%
ML-F	/F	Wide Angle Optic	~70°	n/a
MLF-16	/16	Frosted tight beam optic	16.4°	85.3%
MLF-23	/23	Frosted medium beam optic	22.4°	81.5%
MLF-39	/39	Frosted wide beam optic	38.5°	78.3%
ML-R	/R	90° Reflector	81°	87.9%
ML-R60	/R60	60° Reflector	52.3°	78.3%

#Full Width Half Maximum i.e. total viewing angle, White LED measured

PART NUMBER DESIGNATION:

ML-XX to order as separate item

XXXXX-YYY/ZZ to order with the light

XXXXX = Light Part Number

YYY = Light Color

/ZZ specifies lense option

Example: ML-50 - Purchase 50 degree lense

MLL111.5-WHI/50 - Linear Light, 11.5", White with 50 degree lenses

<p>12° Optic ML-12 /12 (Standard)</p>		<p>16° Frosted Optic MLF-16 /16 (E series Standard)</p>	
<p>30° / 50° Optic ML-30 /30 ML-50 /50</p>		<p>23° Frosted Optic MLF-23 /23</p>	
<p>Line Optic ML-L /L</p>		<p>39° Frosted Optic MLF-39 /39</p>	
<p>F Optic ML-F /F</p>		<p>90° & 60° Reflector ML-R /R ML-R60 /R60</p>	

Spectrum Illumination • 5114 Industrial Park Rd. • Montague, MI 49437

Phone 231-894-4590 • Fax 231-894-4582

www.si-lights.com

Rev. Date: 2018-09-20

Catalog No.	Page #
ALDM350/1	159
ALDM350/2	159
ALDM350/3	159
ALDM700	159
ALDM1050	159
ALDM1400	159
ALDM1750	159
ALDM2100	159
ALDM2800	159
ALDM3500	159
BL14	6
BL18	6
BL22	7
BL24	7
BL26	8
BL34	9
BL36	9
BL38	10
BL44	11
BL46	11
BL48	12
BL56	13
BL66	13
BL68	14
BL88	16
BL210	8
BL312	10
BL414	12
BL610	14
BL612	15
BL618	15
BL812	16
BL824	17
BL1010	17
BL1212	18
DL180-X	40,46,48
DL180-XX	40,46,48
DL180-XXX	42,50
DL180-XXXX	42,50
DLD85-X	46
DLD85-XX	46
DLD180-X	46,48
DLD180-XX	46,48
DLD180-XXX	50
DLD180-XXXX	50
EC3	163
EC5	163
EL150	62
EL300	62
EL2150	64
ES40	124
HBLL111.5	26
HBLL123	26
HBLL134.5	28

Catalog No.	Page #
HLL111.5	26,76
HLL123	26,76
HLL134.5	28,78
LA14	58
LA18	58
LA24	60
LA112	59
LA116	59
LA124	60
LDM350/1	158
LDM350/2	158
LDM350/3	158
LDM700	158
LDM1050	158
LDM1400	158
LDM1750	158
LDM2100	158
LDM2800	158
LDM3500	158
LDM4900	158
MBC-1	162
MBL22	20
MBL24	20
MBL44	22
MBL46	22
MBL48	24
MBLL146	30
MBLL157.5	30
MBLL169	32
MBLL180.5	32
MC4	163
MC4-HO/6	164
MC8	163
MC8-HO/6	164
MC15	163
MC15-HO/6	164
MC30	163
MC30-HO/6	164
MCHF4	163
MCHF4-HO/6	164
MCHF8	163
MCHF8-HO/6	164
MCHF15	163
MCHF15-HO/6	164
MCHF30	163
MCHF30-HO/6	164
MDA2	36
MDA4	36
MDL7.25	54
MDL12.25	54
MDL18.25	55
MDL29.25	55
MLL12	68
MLL14	68
MLL16	70
MLL22	84

Catalog No.	Page #
MLL24	84
MLL26	86
MLL44	86
MLL46	88
MLL48	88
MLL111.5	70
MLL114	68
MLL117.25	72
MLL123	72
MLL128.75	74
MLL134.5	74
MLL146	30,80
MLL157.5	30,80
MLL169	32,82
MLL180.5	32,82
MLLD16	92
MLLD111.5	92
MLLD117.25	94
MLLD123	94
MRL2.5	110
MRL3.5	112
MRL5.5	114
MRL5.5-XXX-YYY	114
MRL8.5	116
MRL13.5	116
MRL19.5	118
MRL30.5	118,120
MRLD3.5	120
MRLD5.5	120
MSP1.25	128
MSP3.25	128
MSP5.5	130
OL66	100
OL1212	100
RL2.5	110
RL3.5	112
RL4	105
RL70	105
RLD3	106
RL/DF4	104
RL/DF8	104
RVLDM350/1	161
RVLDM350/2	161
RVLDM350/3	161
RVLDM700	161
RVLDM1050	161
RVLDM1400	161
RVLDM1750	161
RVLDM2100	161
RVLDM2800	161
RVLDM3500	161
SC4	163
SC8	163
SC15	163
SC30	163
SCHF4	163

Catalog No.	Page #
SCHF8	163
SCHF15	163
TP1	138
TP1-CBR	139
TP1-MBR	139
TP1-MC	139
TP-SC	139
VLDM350/1	160
VLDM350/2	160
VLDM350/3	160
VLDM700	160
VLDM1050	160
VLDM1400	160
VLDM1750	160
VLDM2100	160
VLDM2800	160
VLDM3500	160
WBL28	142
WBL44	142
WBL48	143
WBL812	143
WMC4	163
WMC8	163
WMC15	163
WMC30	163
WMDL7	154
WMLL16	146
WMLL111.5	146
WMLL117.25	148
WMLL123	148
WMRL8.5	154
WMSP1.25	150,154
WMSP3.25	150,154
WRL4	144
WSC4	163
WSC8	163
WSC15	163
WSC30	163
XL300	97
XL2150	97
XS40	134

