



WIELAND

improving
patient
outcomes



healthier hospitals4
 sustainability5
 renewability6
 Wieland story7
 recliner ready program25
 warranty83

patient rooms

sleep sofas
 allay® sleep sofa10
 sleepToo® sleep sofa14
 recliners
 accord™ recliner18
 cove recliner22
 sleep chairs
 accord™ sleep chair26
 capital28
 versant28
 gliders
 capital29
 versant29
 motion chairs
 trace30
 monroe30
 patient chairs
 trace32
 hale.....32
 monroe35
 cove35
 canton35
 capital35
 guest
 perk + SmartRail®36
 plyfold + SmartRail®38
 bariatric
 hale.....40
 monroe40
 cove40
 canton40
 trace41
 upland41
 accord™41
 link41

lounge & waiting

seating
 hale.....44
 canton47

trace48
 monroe51
 rally52
 link54
 upland56
 capital58
 reflect58
 cove58
 benches
 capital59
 reflect59
 easy access chairs
 capital61
 canton62
 cove orthopedic recliner62
 upland62
 trace63

occasional tables

canton66
 amigo66
 monroe66
 drum & cube66
 trace67
 4500 series67
 4700 series67
 50A series68
 cove69
 cube & cylinder69
 kidz69
 sprout69

dining

chairs
 upland72
 kindred74
 plylok74
 tables
 tubular76
 trumpet & disc77

chapel

chairs, pews, chancel and platform furniture79

legacy

seating and tables80-82



enthusiastically supporting the efforts of Healthier Hospitals

Wieland offers a full line of products free of potentially hazardous chemicals. Our desire is to make it easy to specify furniture meeting the Healthy Interiors goal of the Safer Chemicals Challenge.

All of the seating products are free of flame retardants, are GreenGuard® certified, meet PFC (stain repellent) guidance, are PVC-free and comply with UL2818, ANSI/BIFMAX7.1-2011 and ANSI/BIFMA e3-2014e Credit 7.6.1. and 7.6.2. Exceptions to the above are customer specified items such as Fabrics, Thermoform options, or requirements for CA TB133.



sustainability

Sustainable design includes responsible resourcing, continued recycling and enhancing existing internal processes. Compliance with the latest environmental laws and regulations is a natural by-product of our long-term commitment to our customers. We actively seek to conserve, recycle, and act with respect toward our environment.

- 100% of steel, foam, wood, plastic, and corrugated packaging used is recyclable
- 90% of the fabrics offered are environmentally-conscious products
- 70% of supplies come from within a 500 mile radius of NW Ohio and NE Indiana
- All furniture is designed to be easily renewed, maximizing the useful lifespan of the product

greenguard®

GREENGUARD Certification ensures that a product has met some of the world's most rigorous and comprehensive standards for low emissions of volatile organic compounds (VOCs) into indoor air.

Indoor air quality (IAQ) is closely tied to health, it's an important concern in homes, schools, healthcare environments and commercial spaces. VOC emissions from building materials and furnishings is a major source of indoor air pollution. GREENGUARD Certification provides manufacturers with credible tools to verify and promote their sustainability efforts.

GREENGUARD Certification has been widely adopted as a trusted standard for low-emitting products, and has been the basis for the LEED credit for low emitting furniture since 2002.



BIFMA e3 level®

Wieland is proud to demonstrate a commitment to the environment, and to both the quality and performance of products through BIFMA e3 LEVEL testing and certification. Most customers demand that goods be manufactured to meet requirements for quality. And many consumers are also insisting that processes be Safe, Clean and Environmentally friendly or Sustainable.

This certification is a multi-attributed, multi-faceted approach resulting in sustainable manufacturing within the furniture industry. The program provides manufacturers with valuable feedback to better evaluate their impact on the environment, and also on the human population. The program also helps manufacturers gain understanding on the social impact of their furniture products. The LEVEL takes into account the manufacturing, facility, and organization impacts at all levels before granting any certification.



it's what you can't see that's a welcome difference

fabrics

the fabrics are held securely in place with hook and loop closures and are easily removed for cleaning or replacement on-site.

construction

our methods make it easy to access components often with one simple tool.

wood

a strong interior framing made of hardwood baltic birch and plywood, providing more stability than ordinary solid hardwood framing that can crack over time.

moisture barrier

a pliable, laminated waterproof membrane adds protection from liquid damage – spot cleaning becomes a simple task.

foam

only the highest quality, high-density foams are used and are covered under warranty – no exceptions.

environmentally responsible

we actively conserve, recycle and act with respect toward the environment. Going beyond the basics required, we strive for responsible resourcing, recycling and adapting our internal processes and procedures.

finishes

Wieland furniture incorporates a variety of materials and finishes. Any beautiful wood can be custom color matched and has a 2-part polyurethane finish providing superior durability for a long-lasting finish which is easy to clean and disinfect.



original thinking award winning products like sleepToo® and Allay® set the bar in the sleep sofa category, and many of our products are backed by multiple patents.

always sustainable compliance with the latest environmental laws and regulations is a natural by-product of our long-term commitment to our customers.

customer inspired voice of customer (VOC) research provides valuable insight aiding in the creation of innovative, customizable products for changing environments.

service focused an experienced team of dedicated individuals provide prompt service, many of whom have been a part of the Wieland team for 15+ years.

lasting value every product is warranted against failure. If something isn't right; we make it right. If something is broken; we fix it. It's that simple.



p a t i e n t
r o o m



sleep sofas

recliners

sleep chairs

gliders

motion chairs

patient chairs

guest

bariatric

allay[®] sleep sofa





r e s t
r e l a x
r e n e w

sleep sofas



ergonomic
angled seat with
contoured back



intuitive
integrated pull handle
signals movement



cleanability
crumbs fall to
the floor



trundle
space for two people
to sleep

sleep sofas



allay®

sleep sofas



INTERNATIONAL DESIGN
EXCELLENCE AWARDS '12
GOLD

Nightingale Awards
HCD.11 Best of Competition

INTERIOR
DESIGN
**BEST
OF
YEAR 2012**

product
INNOVATIONS

Neotom
Gold
winner

sleepToo[®]
a virtual family room



store your belongings



put up your feet



play a game



rest and recharge



read a book



check your email



celebrate with a meal



cherish the moments

sleep sofas

t h e
f a m i l y
z o n e
r e i n v e n t e d





in only 20 square feet
dine, visit, work, sleep, recline



With sleepToo® existing spaces are reclaimed for storage, opened up as free floor space, or for other uses. sleepToo is the real solution for family-involved care.

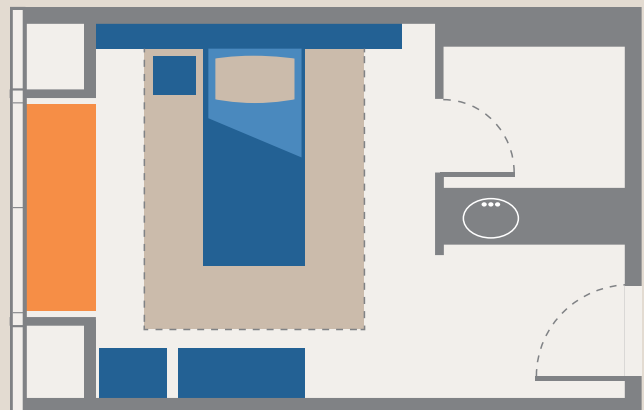

- Family Zone - sleepToo sofa
- Caregiver Zone
- Patient Zone - wardrobes, bedside table, patient chair

accord™ recliner



headrest



intelliTrac caster



pushbar



safeBrake



recliners

accord[™]
the recliner that does



safeBrake grips the floor securely, delivering exceptional stability and makes a solid stop on uneven floors. An industry first, only Wieland separates the casters and brakes. Accord's dedicated brake system out-performs brake systems that are combined with the casters.

intelliTrac[™] casters auto-align and auto-release, offering the control to change direction quickly from straight to sideways. While the chair is tracking straight, a small nudge will move it sideways to help maneuver into tight spaces.



recessed flip table
neatly folds into a stowed position; easy access and cleaning

transfer arm
a front released arm pivots to chair back for an obstacle-free patient transfer

headrest
adjustable height cushion can be easily added to existing recliner

quick release seat
simplifies infection prevention efforts

recline assist bar
for intuitive, effortless reclining; only on sleep and Trendelenburg models



COVE recliner



metal pushbar



bumper guard



recessed arm panel



flip table and metal foot

recliners



unprecedented
reliability

recliners

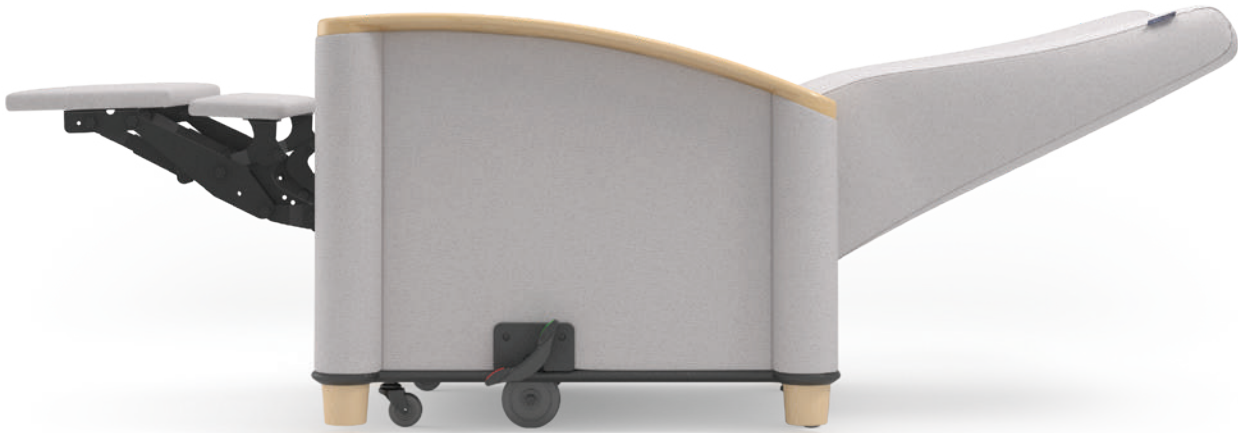

controlled precise movement

cove's unique Trac-Rite casters, zero-turn radius and central brake assure effortless movement in and out of the patient room.

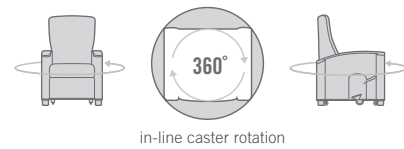

standard back



straight back



pushbar
metal or wood



foot
metal or wood

cove works ... day in and day out for a better patient experience



recessed flip table
3 styles available



retractable footrest
for use during transport



foley bag hook
retrofitable



bumper guards
protects against damage

Cove Recliner Ready ...
order today,
ships tomorrow



When a purchase order is received before 4 pm EST, your order is shipped the following business day. It's just that simple.

- Limit of 10 recliners per order
- Select from pre-specified options

email orders to reclinerready@wielandhealthcare.com

sleep chairs

accord™ sleep chair



wide



easy, one-step conversion to sleep surface



sleep chairs



sleep chairs

capital

- small footprint
- easy one-step conversion



versant

- 3 positions – sit, lounge and sleep
- offered in three widths



capital



versant



encouraging proper nose-over-toes weight distribution



motion chairs

trace



monroe



gentle movement soothes and relaxes





trace

- metal or wood frame
- generous yet subtle cleanout adds to distinct design



hale

- chairs available in 21" and 30" seat widths
- solid surface, thermoform, wood, and nylon arm cap options
- metal arm is available without cap



patient chairs



monroe



canton



cove



capital



guest

perk + SmartRail®





easily cleaned
resin frame

guest

plyfold + SmartRail®

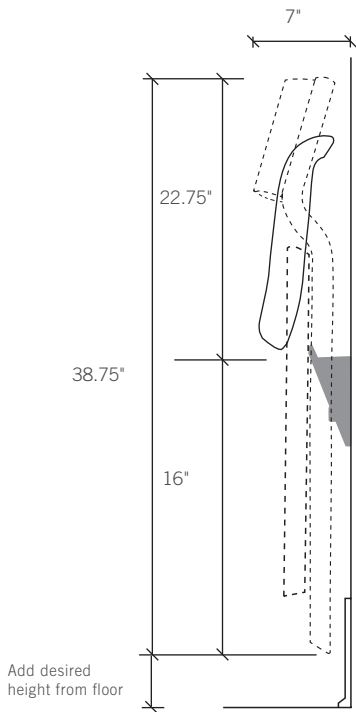

every wall
should have one



hale

- 750 lb weight capacity



canton

- 750 lb weight capacity



monroe

- 750 lb weight capacity



cove

- 500 lb weight capacity



trace

- 750 lb weight capacity



accord™

- 500 lb weight capacity



upland

- 500 lb weight capacity



link

- 750 lb weight capacity







lounge &
waiting

seating
modular
benches
easy access chairs
occasional tables

hale

- powder coated metal frame for easy cleaning
- heavy gauge steel frame welded at all joints
- generous vertical clean out





modern
reliability

lounge & waiting



complementary
comfort



canton

- metal frame in slim oval profile
- customize with aluminum or wood side rails



trace

- elliptical profile adds elegance
- tapered arm cap design





u n m i s t a k a b l e
s t y l e

lounge & waiting



n a t u r a l
w a r m t h

monroe

- distinctive wood frame design
- metal-to-metal seat connection for added durability



rally



round ottomans



completely
versatile

lounge & waiting



interchangeable arm, foot and back styles



armless

embrace
arm

indulge
arm

aspire
arm

compose
arm



inside wedge



corner

lounge & waiting



gangs in
a snap



link

- raised plinth under seat for easy cleaning
- plybent wood frame adds durability
- nylon arm cap standard



modular seating to fit any budget



upland

- multiple seat and back material combinations available
- stools and easy access chairs are offered
- optional wall-saver legs





sustainable
seating

capital

- open and closed arms offer privacy options



cove

- modular waiting is inherently bariatric



reflect

- arm cap, sledbase, mobility front caster and tablet arm options
- bullnose, arcing and sloping arm styles available



arcing arm with wood cap

corridor
solutions



capital bench

capital



reflect



easy access chairs



capital



ideal for
knee and hip
patients



easy access chairs

canton



upland



cove ortho recliner

- seat height is 2" higher



trace

- seat height is 3" higher than standard chairs
- seat depth is 2" shorter than standard chairs
- seat angle is flat



easy access chair

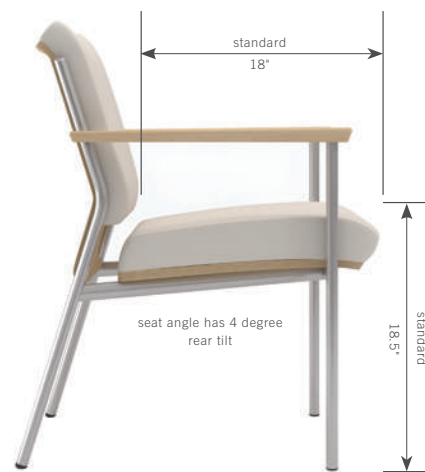

standard chair

occasional tables





occasional tables

occasional tables

canton

- coffee table, and square or round end tables
- laminate top with a smooth metal base



monroe

- coffee table, and square or round end tables
- wood table top and base



amigo

- round or square pull-up table



drum & cube

- durable laminate surface with optional aluminum kick plate



4500 series

- laminate, solid surface or veneer tops
- coffee, console and end tables



4700 series

- thermoform tops
- coffee, console and end tables



trace

- elliptical metal frame with welded joints for superior durability



occasional tables



50A series

- laminate or veneer options



sprout

- laminate tops with steel legs provide the ultimate in strength and durability



kidz

- available in four different heights
- plybent hardwood eliminates fasteners



kid-scale furniture designed to create a place to play

cube & cylinder

- tables are routed and hand-filed for a smooth, custom-crafted finish



cove

- laminate tops with oak or maple wood
- fully renewable



dining





dining

chairs

barstools

tables

dining

upland



reimagine a dining space



seat options



poly



upholstered

arm cap options



black



sterling grey

back options



plastic
available in black, light
grey, and white



upholstered



wood
available as an option on
plastic back models only

plastic back panel options



black



light grey



white

dining

kindred



plylok



plylok frame styles



bar stool



counter stool



sled



4-legged



arm

plylok seat styles



wood seat



upholstered seat
standard width



upholstered seat and back
2" wider seat



upholstered seat and back
2" narrower seat

plylok back styles



mission



round



ladder



tapered



6-slot



3-slot

additional back styles available at wielandhealthcare.com

dining tables

tubular

creating spaces for gathering and collaboration

- 4 base styles
- 7 top shapes
- numerous options



t-base flip top



x-base flip top



modesty panel



seam connector



glide



hard caster



grommet round or oval



trumpet & disc

- 18" and 29" height with round or square tops



chapel

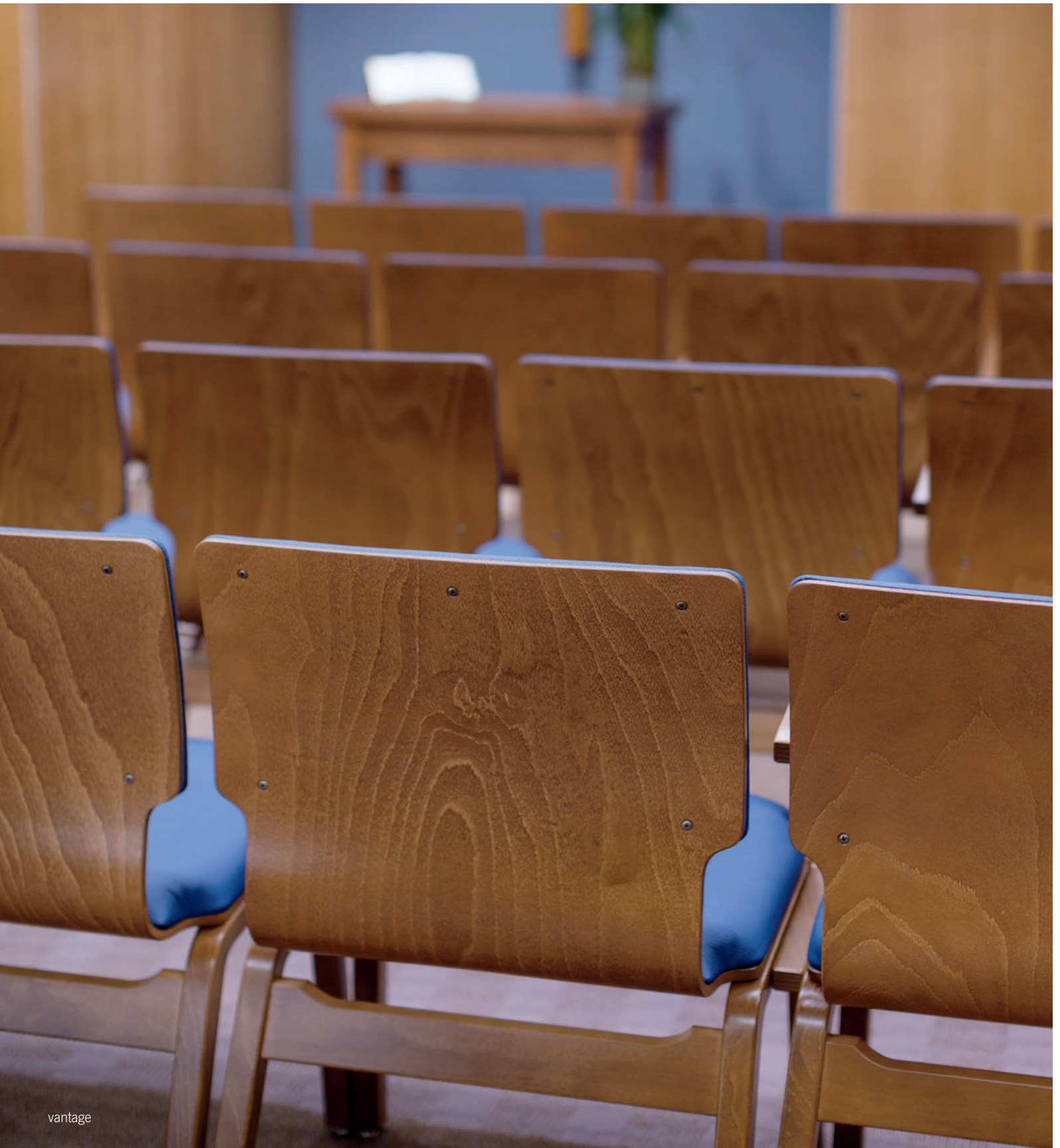

vantage



oaklok with kneeler

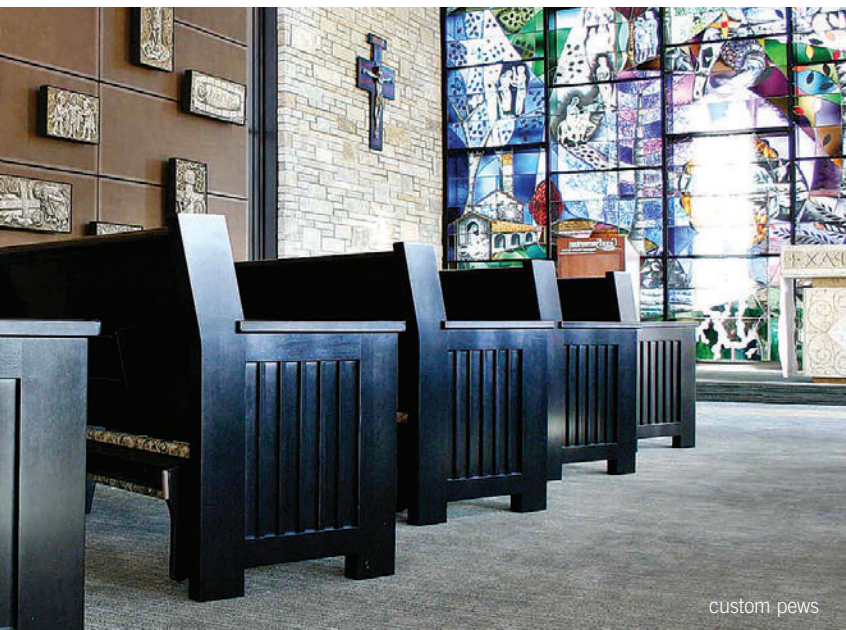

custom pews



unity seating

chapel

Wieland offers numerous options for chapels and spiritual spaces, including chairs, kneelers, platform and chancel furniture, and auditorium seating.

legacy seating

legacy product lines include multiple models with a variety of options. view entire collections at wielandhealthcare.com

	4600 tables	autumn	bridge
dining			
lounges/waiting			
occasional tables			

	cannon	capital	chancel
lounges/waiting			
chapel			

legacy seating

legacy product lines include multiple models with a variety of options. view entire collections at wielandhealthcare.com

	horizon	laurelwood	reflect
patient chair			
glider/rocker			
easy access			
lounge/waiting			
bariatric			
dining			
occasional tables			

legacy seating

legacy product lines include multiple models with a variety of options. view entire collections at wielandhealthcare.com

	versant	wedgewood
patient chair		
glider/rocker		
easy access		
lounge/waiting		
bariatric		
occasional tables		

	oaklok	unity	vantage
chapel			

wieland warranty

All Wieland products are warranted against defects in materials and workmanship and against structural damage incurred through normal use for the periods as noted.

Years under Warranty - Structure							renewability	
Seating	1	2	3	5	10	25	full	component
Accord™						X	X	
Allay®						X	X	
Amigo						X		X
Arris						X	X	
Bridge						X	X	
Cannon						X	X	
Canton						X		X
Capital						X	X	
Chancel						X		
Cove						X	X	
Flow						X	X	
Hale						X		X
Kindred						X		X
Monroe						X		X
Plylok						X		X
Reflect						X	X	
Rally						X	X	
sleepToo®						X	X	
Tables						X		
Trace						X		X
Versant						X	X	
Autumn					X			X
Deli					X			X
Encore-G					X			
Horizon					X			X
Kidz					X			
Laurelwood					X			X
Link					X			X
Mission					X			X
Oaklok					X			X
Parlor					X			X
Perk					X			X
Plyfold					X			X
Trey®-G					X			
Unity					X			X
Upland					X			X
Vantage					X			X
Wedgewood					X			X

Years under Warranty - Structure						
Accessory	1	2	3	5	10	25
Accord™ intelliTrac™					X	
Accord™ Recline Mech					X	
Accord™ safebrake					X	
Accord™ Transfer Arm					X	
Allay® Ottoman Mech					X	
Allay® Drawer Slides		X				
Arris Recliner Mech		X				
Arris Sleep Chair Mech					X	
Capital Recliner Mech		X				
Capital Sleep Chair Mech					X	
Cove Brakes			X			
Cove Recliner Mech					X	
Plyfold SmartRail®					X	
Power Unit - 120V/USB	X					
Pneumatic Cylinder				X		
sleepToo® Drawer Slides		X				
sleepToo® Ottoman Mech					X	
sleepToo® Nylon Back Fabric				X		
sleepToo® Table and Table Mech					X	
Tablet Arms, Casters and Brakes			X			
Versant Recliner Mech					X	

This warranty covers the structure of the furniture: the laminated veneer or solid wood frame, the construction of the arms, table legs and stretchers, and all fasteners. This warranty also covers the foam against defects in its manufacture and composition for this same 25-year period. Under this warranty, Company will, at its option, either replace or repair furniture returned to it or will supply the Customer with replacement parts. Any labor required to upgrade the units may or may not be covered under our warranty without prior consent in writing by Wieland. Any work performed by a non-approved 3rd party will void the warranty. All freight charges for returns or replacements will be paid by Company during the 25-year warranty period. Fabrics, finishes, COM- and all items beyond the control of Company are not covered by this warranty.

WIELAND

888.Wieland

wielandhealthcare.com

