



NEW
PERSPECTIVES
ON SCANDINAVIAN
DESIGN

MUUTO

NEW PERSPECTIVES ON SCANDINAVIAN DESIGN

Muuto is rooted in the Scandinavian design tradition characterized by enduring aesthetics, functionality, craftsmanship and an honest expression.

By expanding this heritage with forward-looking materials, techniques and bold creative thinking, our ambition is to deliver new perspectives on Scandinavian design.

In fact our name, Muuto, comes from *muutos*, meaning new perspective in Finnish. We handpick leading contemporary designers who are strong interpreters of our philosophy and combine their talents with the passionate Muuto creative team.

You will know our design because it has muutos: objects made sublime through new perspectives, enjoyed across the world, representing the best of Scandinavian design today.

2



UNFOLD PENDANT LAMP



OUTLINE SOFA 3 1/2-SEATER
by Anderssen & Vell p. 49

PEBBLE RUG
by Margrethe Odgaard p. 63

FIBER LOUNGE CHAIR
by Iskos-Berlin p. 56

BEAM LAMP
by Tom Chung p. 59

4



The Mini Stacked shelving units create functional storage space while adding to the atmosphere of a room. Display the units on their own, in pairs or in random clusters for a unique yet decorative storage system



FIBER LOUNGE CHAIR
by Iskos-Berlin p. 56

6



PLATFORM TRAY

PLATFORM TRAY
by Sam Hecht & Kim Colin p. 62

70/70 TABLE
by TAF Studio p. 50

LOFT CHAIR
by Thomas Bentzen p. 56

Made from a lacquered steel that gently enfolds its top and bottom in solid oak, the Enfold Sideboard brings industrial storage into the home by combining cold and warm materials for a unique expression



ENFOLD SIDEBOARD
by Thomas Bentzen p. 52

TIP LAMP
by Jens Fager p. 59

COMPILE BOOKEND
by Cecilie Manz p. 62



WORKSHOP CHAIR
by Cecilie Manz p. 53

BASE TABLE
by Mika Tolvanen p. 51

UNDER THE BELL LAMP PENDANT LAMP
by Iskos-Berlin p. 59

MIMIC MIRROR
by Normal Studio p. 63



BEAM LAMP

10



SWAY THROW



STACKED STORAGE SYSTEM
by Julien de Smedt p. 53

LEAF TABLE LAMP
by Broberg & Ridderstråle p. 60

PLY RUG
by Margrethe Odgaard p. 63

OPEN CANDELABRA
by Jens Fager p. 62



LOFT BAR STOOL
by Thomas Bentzen p. 56



E27 PENDANT LAMP
by Mattias Ståhlbom p. 58



CORKY CARAFE & GLASSES
by Andreas Engesvik p. 62



Pebble Rug has a diverse and tactile surface, inspired by the sensuous feeling of walking across a pebbled beach. With a handwoven structure, Pebble Rug contrasts the materials of soft, woolen loops with its sturdy canvas base in a cooling jute yarn

AMBIT RAIL LAMP
by TAF Studio p. 58

VISU BAR STOOL
by Mika Tolvanen p. 57



GROOVE TRIVETS & PLATE
by Hallgeir Homstvedt p. 62

CORKY CARAFE & GLASSES
by Andreas Engesvik p. 62





The E27 Pendant Lamp is a striking naked bulb that plays with the subtle aesthetic and simplicity of industrial design. The lamp can be used as a single light source, in pairs, rows or in clusters for a modern chandelier



REST SOFA
by Anderssen & Voll p. 50

AIRY COFFEE TABLE
by Cecilie Manz p. 51

PLY RUG
by Margrethe Odgaard p. 63

COSY IN WHITE LAMP
by Harri Koskinen p. 59

Loft Chair is a study of applying the ideals of refined simplicity to design. With its sturdy base and plywood seat, the chair fuses the elements of functionality, purity and craftsmanship into a single object



LOFT CHAIR
by Thomas Bentzen p. 56

AMBIT PENDANT LAMP
by TAF Studio p. 58

BASE TABLE
by Mika Tolvanen p. 51



MIMIC MIRROR



HALVES SIDE TABLE
by MSDS p. 51

CONNECT MODULAR SOFA
by Anderssen & Voll p. 49

LEAF FLOOR LAMP
by Broberg & Ridderstråle p. 60

FRAMED MIRROR
by Anderssen & Voll p. 62



FIBER STOOL



VISU CHAIR



OUTLINE STUDIO CHAIR
by Margrethe Odgaard p. 49

OUTLINE STUDIO SOFA
by Cecilie Manz p. 49

AROUND COFFE TABLE
by Thomas Bentzen p. 51

PLY RUG
by Margrethe Odgaard p. 63



HALVES SIDE TABLE



OSLO SOFA
by Anderssen & Voll p. 50

AIRY COFFEE TABLE
by Cecilie Manz p. 51



FIBER ARMCHAIR
by Iskos-Berlin p. 54

BASE TABLE
by Mika Tolvanen p. 51

ENFOLD SIDEBOARD
by Thomas Bentzen p. 52

PUSH COFFEE MAKER
by Mette Duedahl p. 62



RESTORE STORAGE SERIES

RESTORE BASKET & TRAY
by Mika Tolvanen p. 61

70/70 TABLE
by TAF Studio p. 50



FIBER CHAIR
by Iskos-Berlin p. 54

SPLIT TABLE
by Staffan Holm p. 50



MIMIC MIRROR
by Normal Studio p. 63

PLY RUG
by Margrethe Odgaard p. 63

UNDER THE BELL LAMP PENDANT LAMP
by Iskos-Berlin p. 59

Outline marries the ideals of simplicity and function to bring new perspectives on the Scandinavian design sofas of the 1960's. With its shape being a strong outline of a sofa, the Outline Series is clean and elegant on the outside with a deep seat and soft cushioning on its inside



OUTLINE SOFA SERIES
by Anderssen & Voll p. 49

PEBBLE RUG
by Margrethe Odgaard p. 63

AIRY COFFEE TABLE
by Cécilie Manz p. 51

LEAF FLOOR LAMP
by Broberg & Ridderstråle p. 60



THE DOTS COAT HOOKS



Being a modern interpretation of the classic architect's lamp, Tip is both pure and playful with its molded aluminum frame alongside the adjustable head and arm



FIBER BAR STOOL
by Iskos-Berlin p. 55

AMBIT RAIL LAMP
by TAF Studio p. 58

CORKY CARAFE & GLASSES
by Andreas Engesvik p. 62



FOLDED SHELVES



HALVES SIDE TABLE
by MSDS Studio p. 51

UNFOLD PENDANT LAMP
by Form Us With Love p. 58

COMPOSE SOFA
by Anderssen & Voll p. 49

AROUND COFFEE TABLE
by Thomas Bentzen p. 51



COVER CHAIR
by Thomas Bentzen p. 53

GRAIN PENDANT LAMP
by Jens Fager p. 58

70/70 TABLE
by TAF Studio p. 50

CORKY CARAFE & GLASSES
by Andreas Engesvik p. 62



WORKSHOP COFFEE TABLE



FRAMED MIRROR
by Anderssen & Voll p. 62

STACKED STORAGE SYSTEM
by Julien de Smedt p. 53

PLY RUG
by Margrethe Odgaard p. 63

AMBIT PENDANT LAMP
by TAF Studio p. 58



NERD CHAIR



40

AROUND COFFEE TABLE

AROUND COFFEE TABLE
by Thomas Bentzen p. 51

COMPOSE SOFA
by Anderssen & Voll p. 49

SILENT VASE
by Andreas Engesvik p. 63

The Split Table has a natural expression, combining structural solidity with its oak body, infusing the room with warmth to illustrate the essence of Scandinavian design



FIBER SIDE CHAIR
by Iskos-Berlin p. 54

SPLIT TABLE
by Staffan Holm p. 50

AMBIT PENDANT LAMP
by TAF Studio p. 58

PLY RUG
by Margrethe Odgaard p. 63



STACKED SHELVING SYSTEM
by Julien de Smedt p. 53

HALVES SIDE TABLE
by MSDS Studio p. 50

PLY RUG
by Margrethe Odgaard p. 63

COSY IN WHITE LAMP
by TAF Studio p. 59



LEAF FLOOR LAMP
by Broberg & Ridderstråle p. 60

FIVE POUF
by Anderssen & Voll p. 50



The Control Lamp puts the E27 bulb in a new context. With a dial to adjust the light volume, the lamp combines playful industrial style with sleek Scandinavian functionalism and friendly technology



FIVE POUF
by Anderssen & Voll p. 50

OPEN CANDELABRA
by Jens Fager p. 63

COMPILE SHELVING SYSTEM
by Cecilie Manz p. 59

COMPILE BOOKEND
by Cecilie Manz p. 69



NERD BAR STOOL
by David Geckeler p. 56

GRAIN PENDANT LAMP
by Jens Fager p. 58

CORKY CARAFE & GLASSES
by Andreas Engesvik p. 62

CRUSHED BOWL
by Julien de Smedt p. 62



REFLECT SIDEBOARD

FURNITURE
49 — 57

LIGHTING
58 — 60

ACCESSORIES
61 — 64

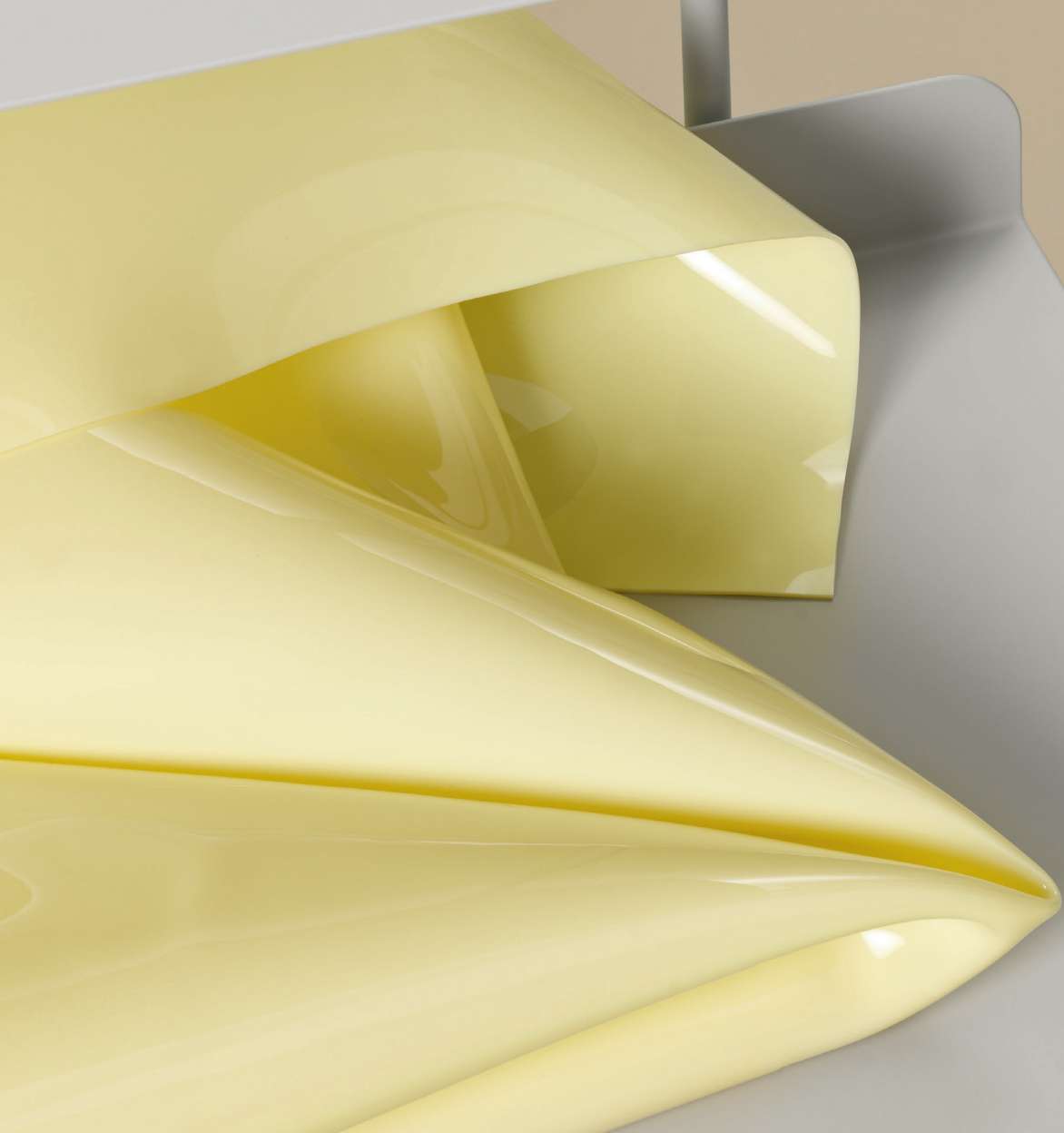

OUTLINE SOFA by Anderssen & Voll

Corner Sofa

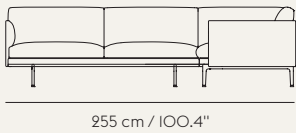

255 cm / 100.4"

2-Seater

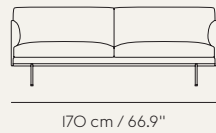

170 cm / 66.9"

Chaise Longue

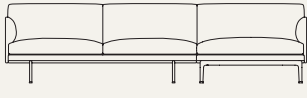

265 cm / 104.3"

Chair

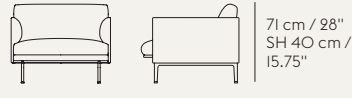

88 cm / 34.6" 86 cm / 33.9"

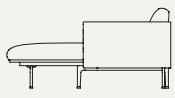

142 cm / 55.9"

Studio Sofa

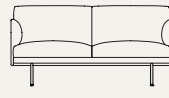

140 cm / 55.1"

3 1/2-Seater

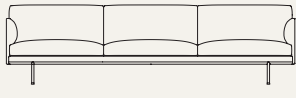

255 cm / 100.4"

Studio Chair

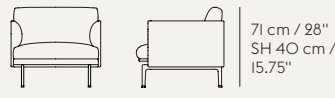

70 cm / 30.7" 76 cm / 29.9"

3-Seater

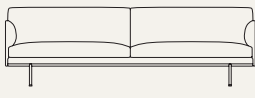

220 cm / 86.6"

Pouf

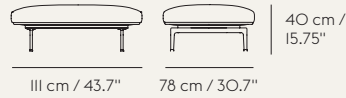

111 cm / 43.7" 78 cm / 30.7"

High Back 3-Seater

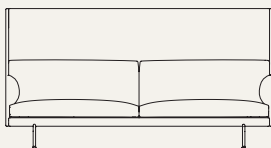

220 cm / 86.6"

High Back 2-Seater

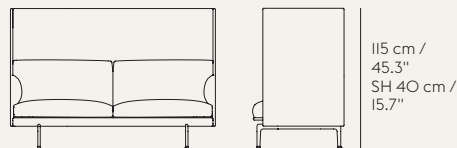

170 cm / 66.9"

76 cm / 29.9"



OPTION

The Outline Corner, 3 1/2-Seater, Pouf, Highback- and Studio versions available as made-to-order. Other textiles and leather upholstery are available as made-to-order for the entire series

MATERIAL

Powder coated aluminum legs. Wood and steel construction. Cold foam filling. All textiles from Kvadrat or Arve. Leather from Camo Leathers

CONNECT MODULAR SOFA by Anderssen & Voll

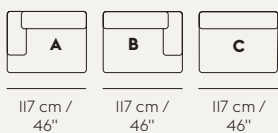

117 cm / 46" 117 cm / 46" 117 cm / 46"

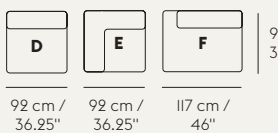

92 cm / 36.25" 92 cm / 36.25" 117 cm / 46"

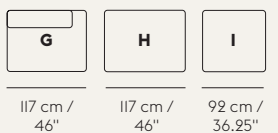

117 cm / 46" 117 cm / 46" 92 cm / 36.25"

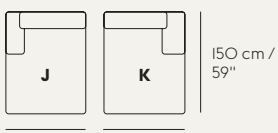

117 cm / 46" 117 cm / 46"

150 cm / 59"



MATERIAL

Cold foam, wooden frame. All textiles from Kvadrat, Nevotex, Fidertessile and Arve

OPTIONS

Combine your sofa setup from 11 different modules. Modules H, I, J & K are made-to-order. Other textiles are available as made-to-order

COMPOSE SOFA by Anderssen & Voll

3-Seater

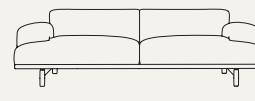

240 cm / 94.5"

2-Seater

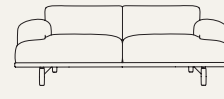

200 cm / 78.75"



94 cm / 37"



OPTION

Option of black legs made-to-order. Other textiles are available as made-to-order options

MATERIAL

Wooden frame, steel rails and cold-foam filling. Oak legs. All textiles from Kvadrat, Fidertessile, Nevotex or Arve

REST SOFA
by Anderssen & Voll

3-Seater

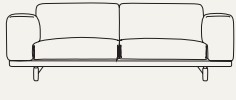

260 cm / 102.5"

2-Seater



200 cm / 78.75"



72 cm / 28.75"
SH 42 cm / 16.5"

92 cm / 36.25"

Studio Sofa

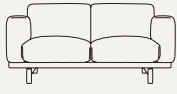

165 cm / 65"



72 cm / 28.75"
SH 42 cm / 16.5"

87 cm / 34.25"

Pouf



42 cm / 16.5"

100 cm / 39.5" 80 cm / 36.25"



OPTION

Grey and black legs available made-to-order. The Rest Studio Sofa and Pouf are made-to-order

MATERIAL

Steel base, wooden frame, cold foam and feather filling. All textiles from Kvadrat, Nevotex and Arve

OSLO SOFA
by Anderssen & Voll

3-Seater

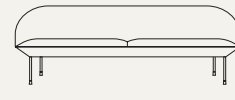

200 cm / 78.75"

2-Seater

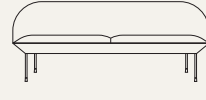

150 cm / 59"

Chair



80 cm / 31.5"

73 cm / 28.75"

78 cm / 30.75"
SH 45 cm / 17.75"

Bench



150 cm / 59"

Pouf

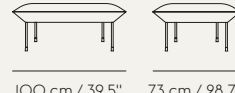

100 cm / 39.5"

73 cm / 28.75"



OPTION

The Oslo Bench and Pouf are made-to-order. Other textiles and leg colors are available as made-to-order options

MATERIAL

Inner frame of steel, legs of aluminum with powder coated surface, casted foam. All textiles from Kvadrat

FIVE POUF
by Anderssen & Voll

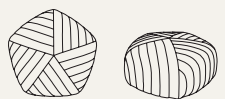

88 cm / 34.5" 53 cm / 21"

45 cm / 17.75"



OPTION

Extra large pouf and other textiles available as made-to-order options

MATERIAL

Wooden frame and molded foam
All textiles from Kvadrat

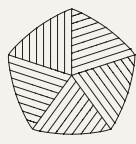

140 cm / 55"



85 cm / 33.5"

45 cm / 17.75"

70/70 TABLE
by TAF Studio

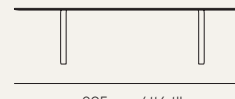

295 cm / 116.1"

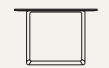

73 cm / 28.75"

108 cm / 42.5"

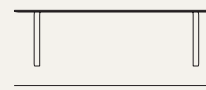

255 cm / 100.5"

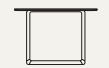

73 cm / 28.75"

108 cm / 42.5"

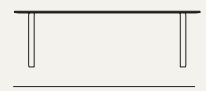

225 cm / 88.5"

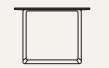

73 cm / 28.75"

90 cm / 35.5"

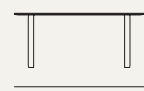

170 cm / 67"



73 cm / 28.75"

85 cm / 33.5"



MATERIAL

Table top of pine plywood with grey or black linoleum, white laminate or oak veneer. Cast aluminum frame.
*295 x 108 not available in white or white/black laminate

SPLIT TABLE
by Staffan Holm



220 cm / 86.5"



73 cm / 28.75"

90 cm / 35.5"



Oak

MATERIAL

Oak

BASE TABLE RECTANGULAR & ROUND
by Mika Tolvanen

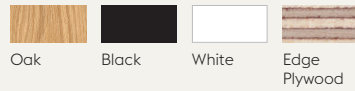
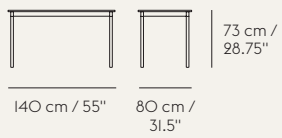

MATERIAL
Table top in either furniture board with laminate surface and ABS edges or table top in plywood with linoleum or laminate surface. Base in extruded aluminum

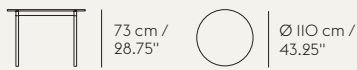
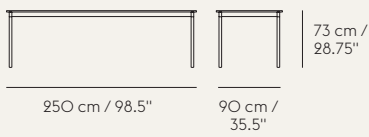
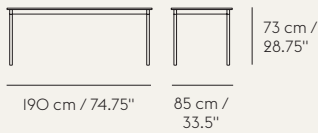
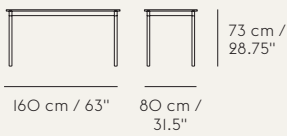

AROUND COFFEE TABLE
by Thomas Bentzen

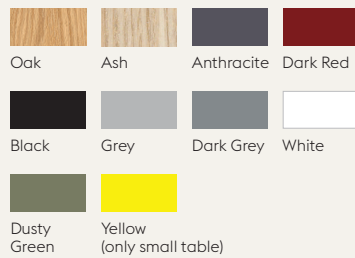
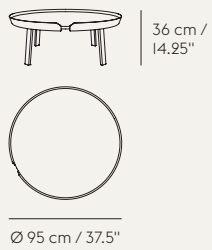

MATERIAL
Tabletop made from ash or oak plywood. Legs made of solid lacquered ash or oak

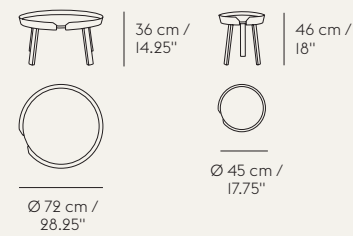

HALVES SIDE TABLE
by MSDS Studio

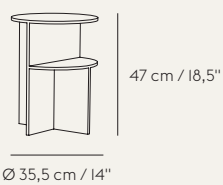

MATERIAL
Acrylic stone composite

BASE HIGH TABLE
by Mika Tolvanen

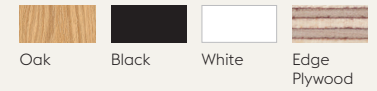
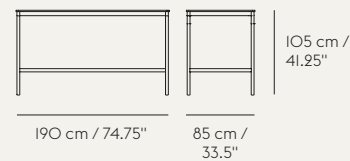

MATERIAL
Table top in either furniture board with laminate surface and ABS edges or table top in plywood with linoleum or laminate surface. Base in extruded aluminum with legs and stretcher in iron

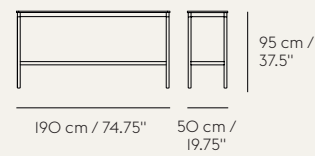
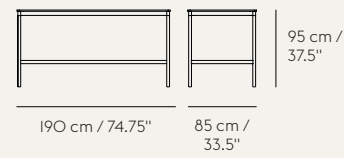
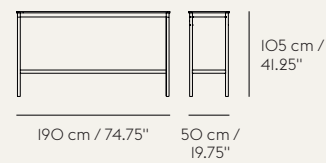

AIRY COFFEE TABLE
by Cecilie Manz

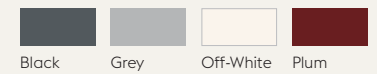
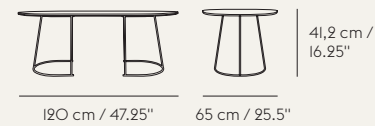

MATERIAL
Plywood tabletop with nano-laminate surface, powder coated solid steel frame

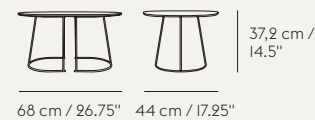
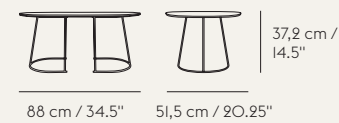

WORKSHOP COFFEE TABLE
by Cecilie Manz

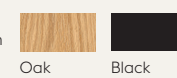
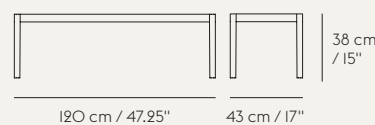

MATERIAL
Legs and frame in solid wood. Tabletop in oak veneer. Black version comes in a lacquered oak. Oak version comes with a matte clear lacquer

ENFOLD SIDEBOARD
by Thomas Bentzen

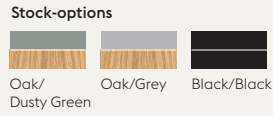
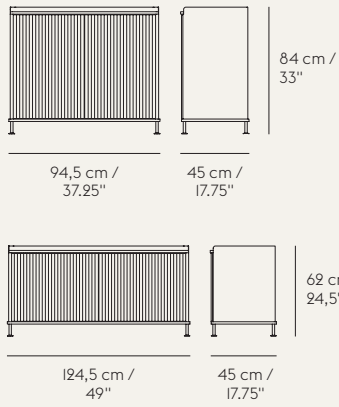

MATERIAL
Body, shelves and sliding doors in lacquered, bended steel. Top and base in solid oak with a matte clear lacquer

REFLECT SIDEBOARD & DRAWER
by Søren Rose Studio

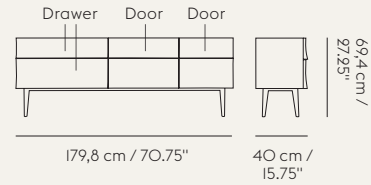

MATERIAL
Oak wood

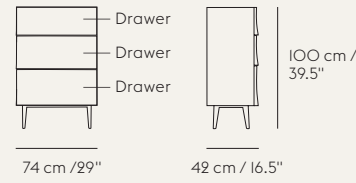
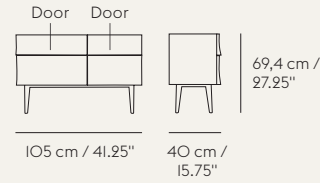

Please note that the Reflect Drawer is not available for sale in North America and South America

COMPILE SHELVING SYSTEM
by Cecilie Manz

Prearranged configurations

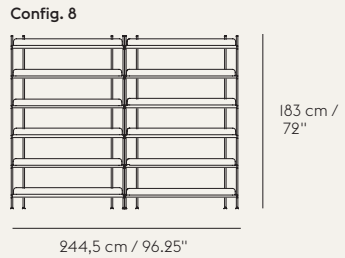
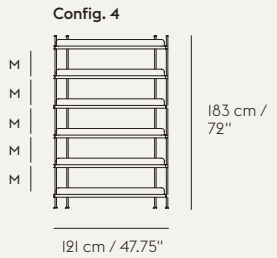
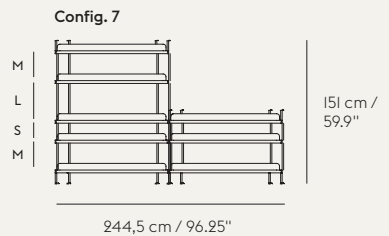
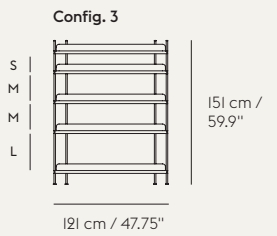
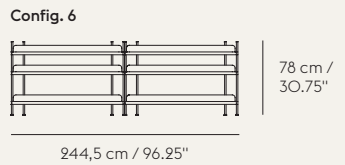
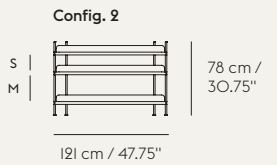
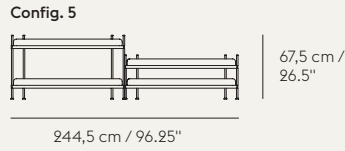

Shelf

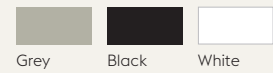
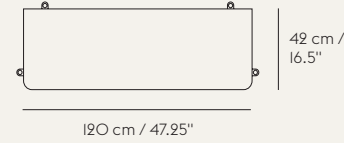

MATERIAL
Powder coated steel

Dividers

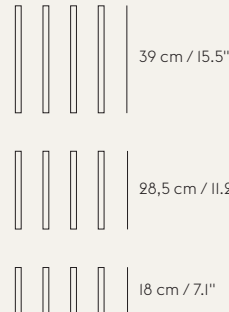

Essentials Pack

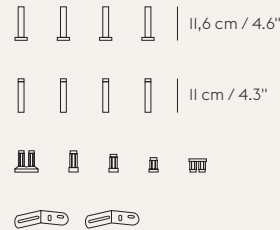

OPTION
Build personalized systems by assembling shelves with 3 sizes of dividers or choose between 8 prearranged configurations

WEIGHT & HEIGHT RECOMMENDATIONS

The Compile Shelving System should always be mounted to a wall using wall brackets (included in the essentials pack). A Compile Shelving System can hold up to 300 kg / 661 lb. The Compile Shelving Systems can be built as tall as wanted, as long as it is mounted to the wall using wall brackets. Muuto recommends not building configurations higher than 2,25 m / 88.5".

STACKED STORAGE SYSTEM

by Julien De Smedt



Inspiration for your stacked storage system

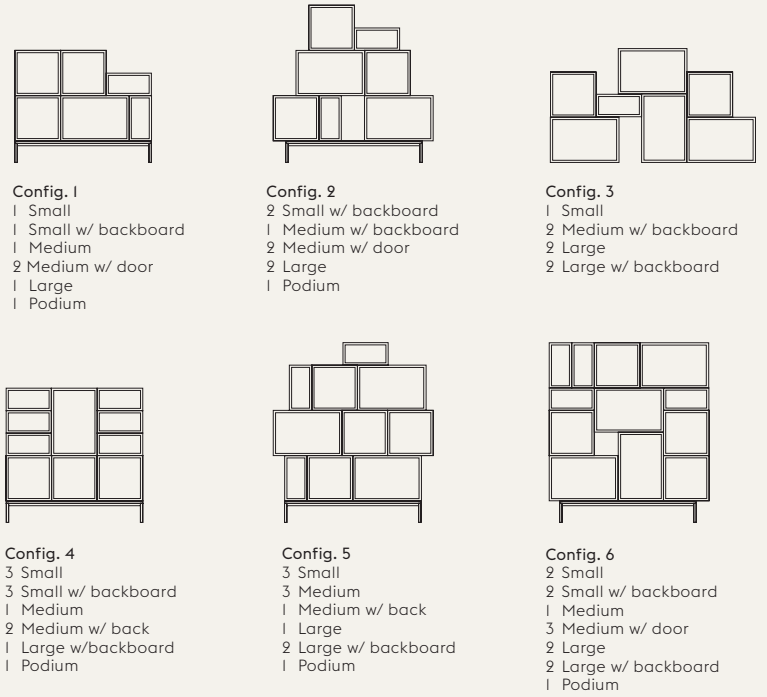

The Stacked Storage System complies with the European requirements for safety, strength, durability and stability within storage — EN 16121:2013 and EN 16122:2012 — when following the assembly and configuration guidelines.

Create your own storage solution with the Muuto Stacked Configurator. See our configuration guidelines and design your own Stacked setup on stackedconfigurator.muuto.com.

MINI STACKED STORAGE SYSTEM

by Julien De Smedt



STACKED ACOUSTIC PANELS

by Julien De Smedt

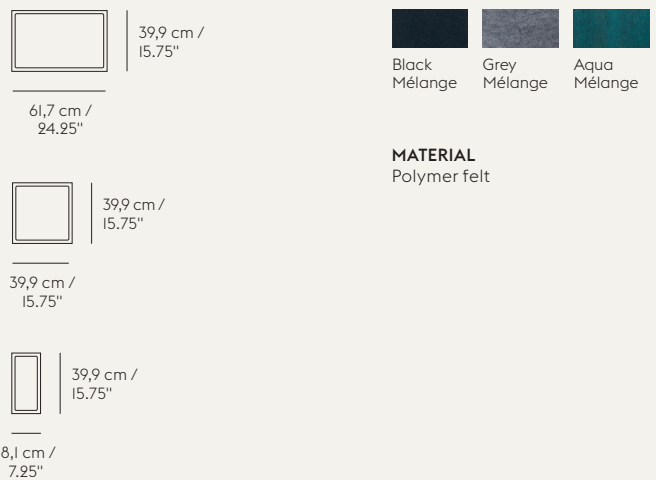

WORKSHOP CHAIR

by Cecilie Manz



COVER CHAIR

by Thomas Bentzen

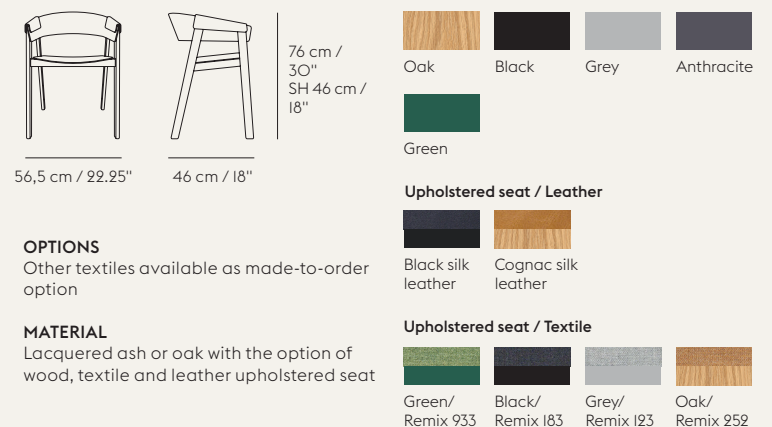

FIBER ARMCHAIR TUBE & SLED BASE
by Iskos-Berlin

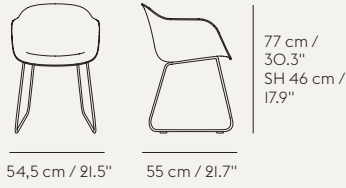
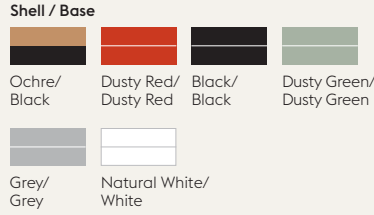
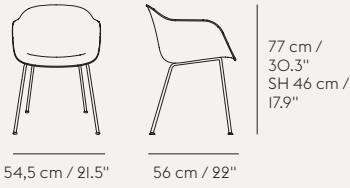

OPTION
Front upholstery and full upholstery versions with other textiles and leather available as made-to-order options

MATERIAL
Shell in form-pressed composition of polypropylene with up to 25% wood fibers. Option of textile and leather upholstered seat. Base in powder coated steel

FIBER ARMCHAIR SWIVEL BASE & SWIVEL BASE W. CASTORS
by Iskos-Berlin

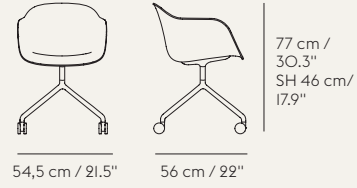
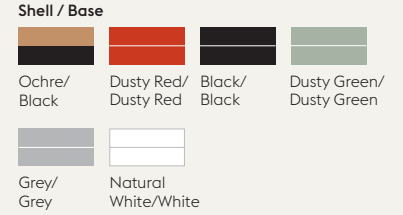
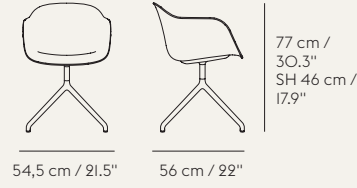

OPTION
Front upholstery and full upholstery versions with other textiles or leather available made-to-order. Swivel base w. castors also available with gas lift

MATERIAL
Shell in form-pressed composition of polypropylene with up to 25% wood fibers. Option of textile and leather upholstered seat. Base in aluminum

FIBER ARMCHAIR WOOD BASE
by Iskos-Berlin

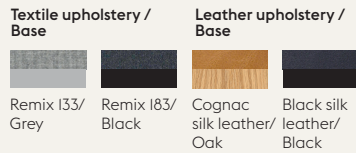
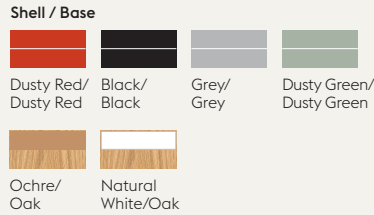
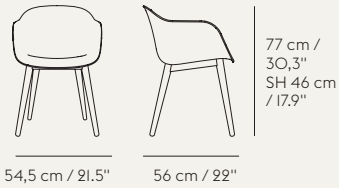

OPTION
Front upholstery and full upholstery versions with other textiles and leather available as made-to-order options

MATERIAL
Shell in form-pressed composition of polypropylene with up to 25% wood fibers. Option of textile and leather upholstered seat. Base in solid oak and plywood

FIBER SIDE CHAIR WOOD BASE
by Iskos-Berlin

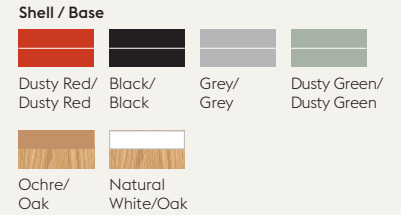

OPTION
Other textiles and leather upholsteries available as made-to-order options

MATERIAL
Shell in form-pressed composition of polypropylene with up to 25% wood fibers. Option of textile and leather upholstered seat. Base in solid oak and plywood

FIBER SIDE CHAIR TUBE & SLED BASE
by Iskos-Berlin

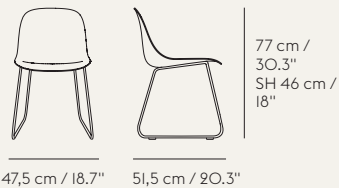
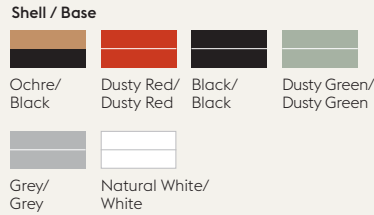
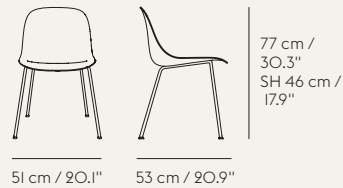

OPTION
Other textiles and leather upholsteries available as made-to-order options

MATERIAL
Shell in form-pressed composition of polypropylene with up to 25% wood fibers. Option of textile and leather upholstered seat. Base in powder coated steel

FIBER SIDE CHAIR SWIVEL BASE & SWIVEL BASE W. CASTORS
by Iskos-Berlin

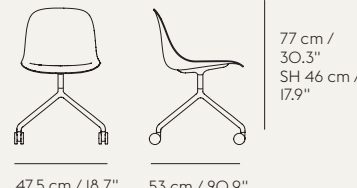
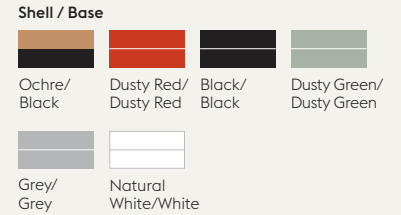

OPTION
Front upholstery and full upholstery versions with other textiles or leather available made-to-order. Swivel base w. castors is also available with gas lift

MATERIAL
Shell in form-pressed composition of polypropylene with up to 25% wood fibers. Option of textile and leather upholstered seat. Base in aluminum

FIBER BAR STOOL W. BACK TUBE BASE
by Iskos-Berlin

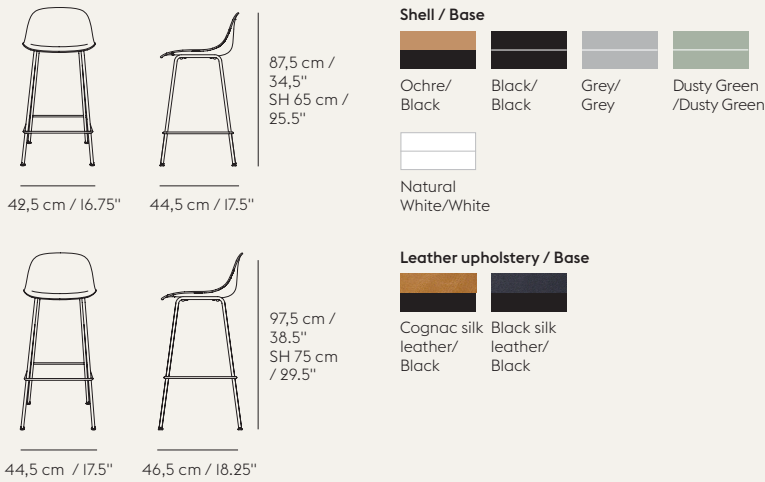

OPTIONS
Textile upholstered and 75 cm height versions available as made-to-order options

MATERIAL
Shell in form-pressed composition of polypropylene with up to 25% wood fibers. Option of textile and leather upholstered seat. Base in powder coated steel

FIBER BAR STOOL W. BACK WOOD BASE
by Iskos-Berlin

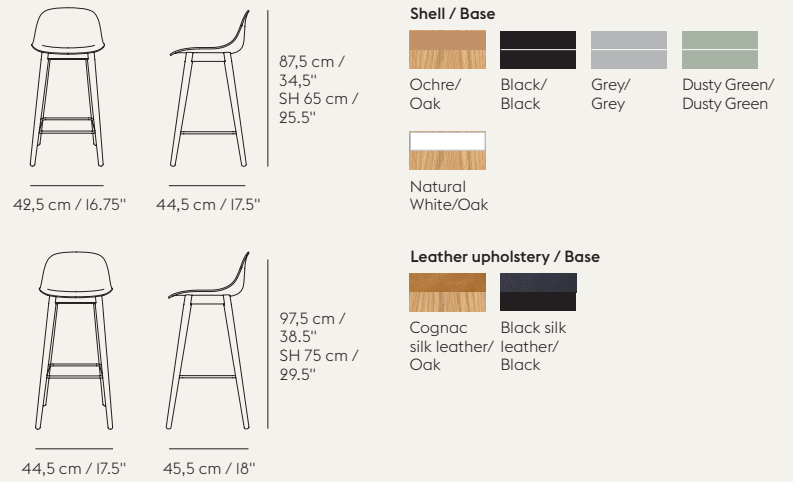

OPTIONS
Textile upholstered and 75 cm height versions available as made-to-order options

MATERIAL
Shell in form-pressed composition of polypropylene with up to 25% wood fibers. Option of textile and leather upholstered seat. Base in solid oak and plywood

FIBER BAR STOOL TUBE BASE
by Iskos-Berlin



OPTIONS
Textile upholstered and 75 cm height versions available as made-to-order options

MATERIAL
Shell in form-pressed composition of polypropylene with up to 25% wood fibers. Option of textile and leather upholstered seat. Base in powder coated steel

FIBER BAR STOOL WOOD BASE
by Iskos-Berlin

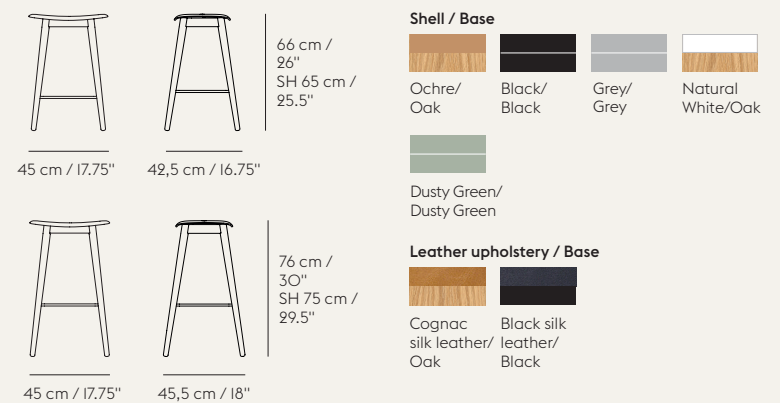

OPTIONS
Textile upholstered and 75 cm height versions available as made-to-order options

MATERIAL
Shell in form-pressed composition of polypropylene with up to 25% wood fibers. Option of textile and leather upholstered seat. Base in solid oak and plywood

FIBER STOOL TUBE BASE
by Iskos-Berlin

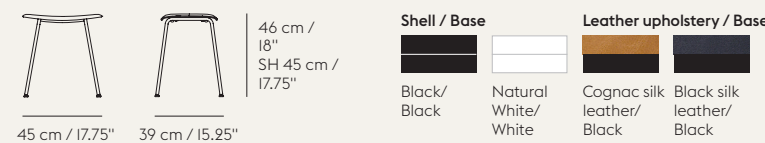

OPTIONS
Other textile upholstered versions available as made-to-order options

MATERIAL
Shell in form-pressed composition of polypropylene with up to 25% wood fibers. Option of textile and leather upholstered seat. Base in powder coated steel

FIBER STOOL WOOD BASE
by Iskos-Berlin

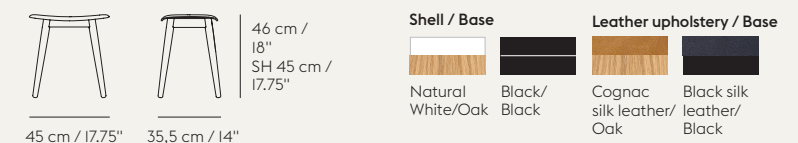

OPTIONS
Other textile upholstered versions available as made-to-order options

MATERIAL
Shell in form-pressed composition of polypropylene with up to 25% wood fibers. Option of textile and leather upholstered seat. Base in solid oak and plywood

FIBER LOUNGE CHAIR TUBE BASE
by Iskos-Berlin

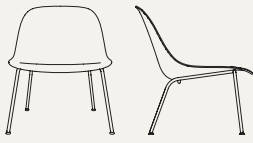

60 cm / 23.6"

69 cm / 27.2"

74,4 cm /
29.3"
SH 38 cm
/ 15"

Textile upholstery / Base

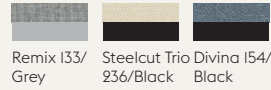

Remix 133/
Grey Steelcut Trio 236/
Black Divina 154/
Black

Leather upholstery / Base



Cognac silk
leather/Black

OPTION

Other textiles or leather upholsteries
available as made-to-order options

MATERIAL

Shell in form-pressed composition of
polypropylene with up to 25% wood fibers.
Textile and leather upholstered seat. Base
in powder coated steel

FIBER LOUNGE CHAIR WOOD BASE
by Iskos-Berlin



60 cm / 23.6"

69 cm / 27.2"

74,4 cm /
29.3"
SH 38 cm
/ 15"

Textile upholstery / Base

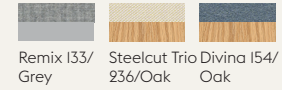

Remix 133/
Grey Steelcut Trio 236/
Oak Divina 154/
Oak

Leather upholstery / Base



Cognac silk
leather/Oak

OPTION

Other textiles or leather upholsteries
available as made-to-order options

MATERIAL

Shell in form-pressed composition of
polypropylene with up to 25% wood fibers.
Textile and leather upholstered seat. Base
in solid oak and plywood

NERD CHAIR
by David Geckeler

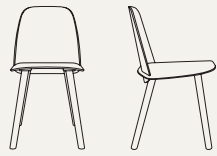

45 cm / 17.75"

50 cm / 19.75"

79,9 cm /
31"
SH 46 cm /
18"



Oak Petroleum Dark Grey Grey
Green Black Rose White



Dark Red

MATERIAL

Natural oak or lacquered ash

NERD BAR STOOL
by David Geckeler

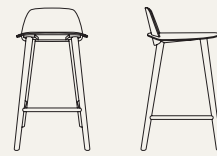

40 cm / 15.75"

42 cm / 16.5"

79 cm / 31"
SH 65 cm /
25.5"



Oak Petroleum Dark Grey Grey
Green Black White Dark Red

OPTION

Bar stool in two seat heights - 65 cm or 75
cm

MATERIAL

Natural oak or lacquered ash



45 cm / 17.75"

46 cm / 18"

89 cm / 35"
SH 75 cm /
29.5"

LOFT CHAIR
by Thomas Bentzen

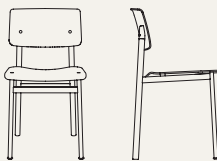

42,5 cm / 31"

48 cm / 19"

78,5 cm /
31"
SH 46 cm /
18"

Shell/base - Stock version

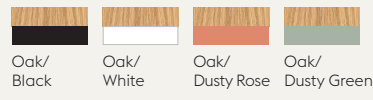

Oak/ Black Oak/ White Oak/ Dusty Rose Oak/ Dusty Green



Black/
Black

Shell / base / textile - Made-to-order



Black/ Black/ Steelcut 190 Oak/ White/ Steelcut Trio 205 Oak/ Dusty Green/ Steelcut Trio 966 Oak/ Dusty Rose/ Steelcut Trio 515



Oak/
Black/
Steelcut
190

OPTION

Chairs with upholstered seat is available
made-to-order in a large range of textiles
and colors

MATERIAL

Back and seat in oak veneer. Frame in
powder coated steel

LOFT BAR STOOL
by Thomas Bentzen

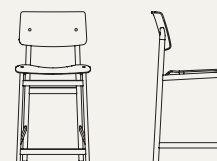

42,5 cm / 16.75"

49 cm / 19.25"

98,5 cm /
38.75"
SH 65 cm /
25.5"

Shell/base - Stock version

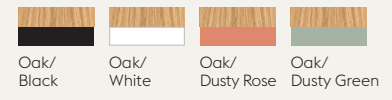

Oak/ Black Oak/ White Oak/ Dusty Rose Oak/ Dusty Green



Black/
Black

Shell / base / textile - Made-to-order



Black/ Black/ Steelcut 190 Oak/ White/ Steelcut Trio 205 Oak/ Dusty Green/ Steelcut Trio 966 Oak/ Dusty Rose/ Steelcut Trio 515



Oak/
Black/
Steelcut
190

OPTION

Bar stools with upholstered seat is
available made-to-order in a large range
of textiles and colors

MATERIAL

Back and seat in oak veneer. Frame in
powder coated steel

VISU CHAIR WOOD BASE
by Mika Tolvanen



78,5 cm / 31"
SH 46 cm / 18"

46 cm / 18" 51 cm / 20"

Shell / Base

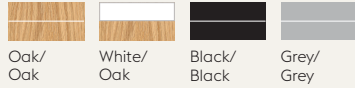

OPTIONS

Other textiles available as made-to-order options

MATERIAL

Lacquered ash or oak veneer shell with the option of wood, textile or leather upholstered seat

VISU CHAIR SLED BASE
by Mika Tolvanen

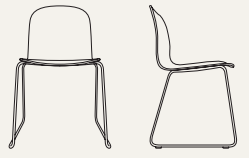

78 cm / 30.75"
SH 46 cm / 18"

53,5 cm / 21" 50 cm / 19.5"

Shell / Base



OPTIONS

Other textiles available as made-to-order options

MATERIAL

Lacquered ash or oak veneer shell with the option of wood, textile or leather upholstered seat. Powder coated steel base

VISU CHAIR TUBE BASE
by Mika Tolvanen



78 cm / 30.75"
SH 46 cm / 18"

53,5 cm / 21" 50 cm / 19.75"

Shell / Base



MATERIAL

Lacquered ash or oak veneer shell with the option of wood, textile or leather upholstered seat. Powder coated steel base

VISU WIDE CHAIR WOOD BASE & SWIVEL BASE
by Mika Tolvanen



78,5 cm / 31"
SH 45 cm / 17.75"

50 cm / 19.75" 55 cm / 21.75"

Shell / Base

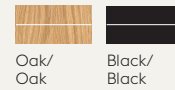

OPTION

The Visu Wide Chair is available as a made-to-order option

MATERIAL

Lacquered ash or oak veneer shell with the option of wood, textile or leather upholstered seat



78,5 cm / 31"
SH 45 cm / 17.75"

50 cm / 19.75" 55 cm / 21.75"

VISU BAR STOOL
by Mika Tolvanen



78,5 cm / 31"
SH 65 cm / 25.5"

42,7 cm / 16.75" 42,3 cm / 16.75"

Shell / Base



OPTION

Bar stool in two seat heights - 65 cm or 75 cm. Bar stools with upholstered seat are available as made-to-order

MATERIAL

Lacquered ash or oak veneer shell
Foot rest in lacquered or stainless steel



88,5 cm / 34.75"
SH 75 cm / 29.5"

42,7 cm / 16.75" 42,3 cm / 16.75"

VISU LOUNGE CHAIR
by Mika Tolvanen



69 cm / 27.25"
SH 40 cm / 15.75"

60 cm / 23.5" 51 cm / 20"

Shell / Base



Textile upholstery / Base

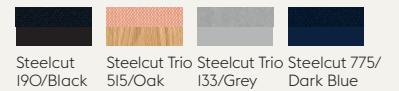

OPTIONS

Other textiles available as made-to-order options

MATERIAL

Lacquered ash or oak veneer shell with the option of wood, textile or leather upholstered seat

LIGHTING

E27 PENDANT LAMP by Mattias Ståhlbom



MATERIAL
Silicone rubber

LIGHT SOURCE
2W LED bulb included

UNFOLD PENDANT LAMP by Form Us With Love

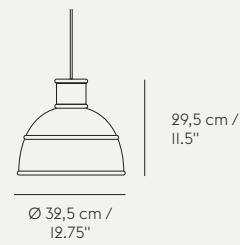

MATERIAL
Silicone rubber

LIGHT SOURCE
Max. 60W

Lighting

AMBIT PENDANT LAMP by TAF Studio

58

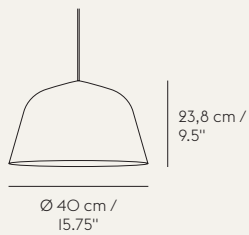

MATERIAL
Spun aluminum shade, rubber cord

LIGHT SOURCE
Max. 60W



AMBIT RAIL LAMP by TAF Studio

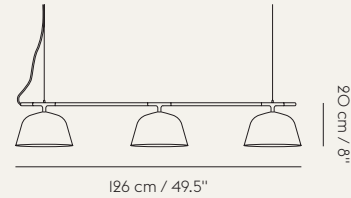

MATERIAL
Rail made from cast and extruded aluminum. Shades in spun aluminum with a rubber cord and steel wires

LIGHT SOURCE
Max. 60W

STUDIO PENDANT LAMP by Thomas Bernstrand

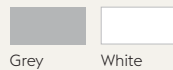
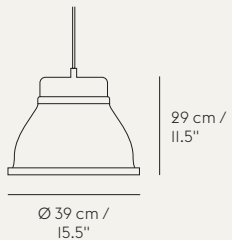

MATERIAL
Solid aluminum

LIGHT SOURCE
Max. 40W

Please note that Studio Pendant Lamp is not available for sale in the U.S.

GRAIN PENDANT LAMP by Jens Fager

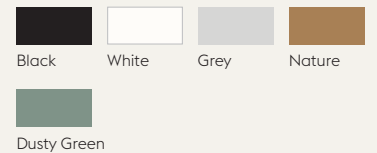

MATERIAL
Mixture of bamboo fibers & plastic, rubber cord

LIGHT SOURCE
4W LED bulb included

FLUID PENDANT LAMP
by Claesson Koivisto Rune

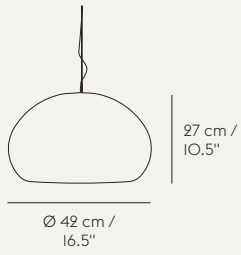

Opal White

MATERIAL
White opal glass, matte finish

LIGHT SOURCE
Small 3W LED bulb included / Large max 60W

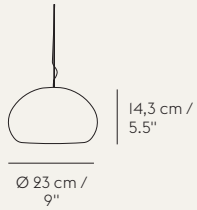

UNDER THE BELL LAMP
by Iskos-Berlin

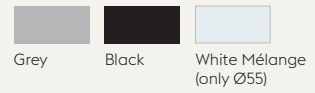
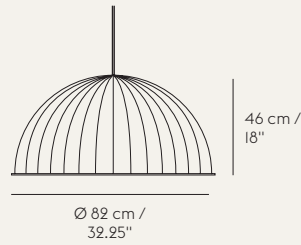

Grey Black White Mélange (only Ø55)

MATERIAL
Recycled PET felt, rubber cord

LIGHT SOURCE
Max. 30W

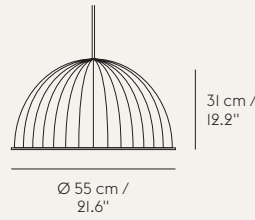

BEAM LAMP
by Tom Chung

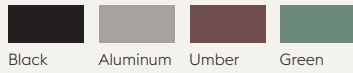
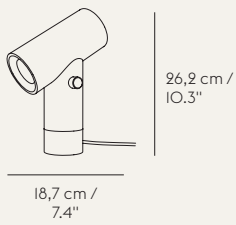

Black Aluminum Umber Green

MATERIAL
Extruded aluminum. PVC cord

LIGHT SOURCE
Integrated IOW LED x 2

TIP LAMP
by Jens Fager

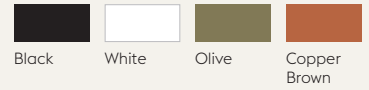

Black White Olive Copper Brown

MATERIAL
Casted aluminum, rubber cord

LIGHT SOURCE
7W LED bulb included

CONTROL LAMP
by TAF Studio

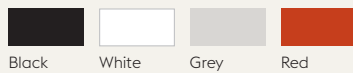
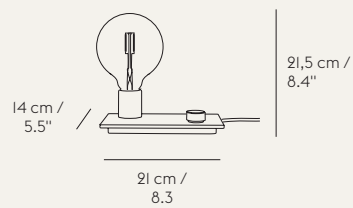

Black White Grey Red

MATERIAL
Casted aluminum

LIGHT SOURCE
2W LED bulb included

WOOD LAMP
by TAF Studio

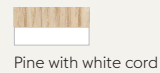
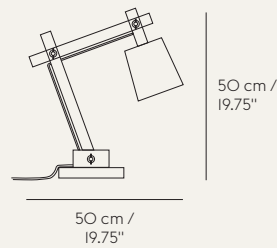

Pine with white cord

MATERIAL
Pine wood, rubber cord

LIGHT SOURCE
Max. 7W LED

Please note that Wood Lamp is not available for sale in the U.S.

COSY IN WHITE LAMP
by Harri Koskinen

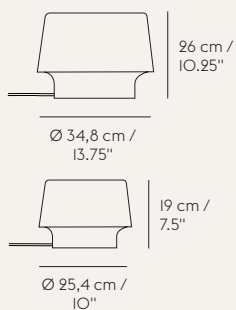

White

MATERIAL
Mouth-blown opal glass

LIGHT SOURCE
Small max. 40W / large max. 60W

COSY IN GREY LAMP
by Harri Koskinen

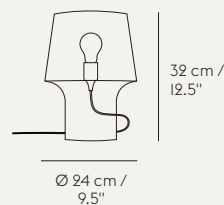

Grey

MATERIAL
Mouth-blown glass

LIGHT SOURCE
Max. 60W

Please note that Cosy in White Lamp - Large is not available for sale in the U.S.

FOCUS LAMP
by Andreas Bergsaker



Black

MATERIAL
Turned ash wood

LIGHT SOURCE
2W LED bulb included

Please note that Focus Lamp is not available for sale in the U.S.

LEAF TABLE LAMP
by Broberg & Ridderstråle

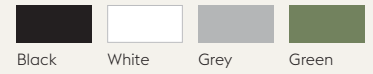
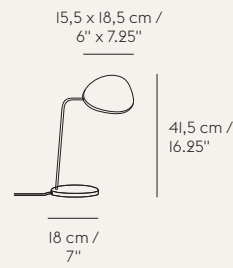

Black White Grey Green

MATERIAL
Aluminum, brass

LIGHT SOURCE
8W LED bulb included

PULL LAMP
by Whatswhat

Lighting

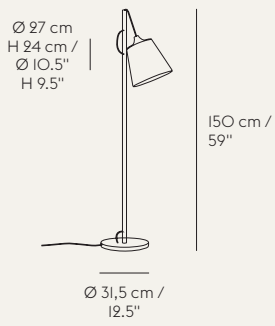

White/Oak

MATERIAL
Oiled oak wood, textile cord, textile covered plastic shade

LIGHT SOURCE
Max. 60 W

Please note that Pull Lamp is not available for sale in the U.S.

LEAF FLOOR LAMP
by Broberg & Ridderstråle

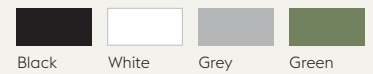

Black White Grey Green

MATERIAL
Aluminum, brass

LIGHT SOURCE
8W LED bulb included

LEAN LAMP
by Claesson Koivisto Rune



Black White Grey Dusty Green

MATERIAL
Casted aluminum, rubber cord

LIGHT SOURCE
2W LED bulb included

Please note that Lean Lamp is not available for sale in the U.S.

ACCESSORIES

THE DOTS COAT HOOKS

by Lars Tornøe



MATERIAL

Oak or ash wood. Colored versions in ash wood

OPTIONS

Available in single packages. Oak, black, grey and white versions are also available in gift boxes with 1 large, 1 medium and 3 small Dots. Please be aware that Walnut is not available in ekstra small

THE DOTS METAL COAT HOOKS

by Lars Tornøe

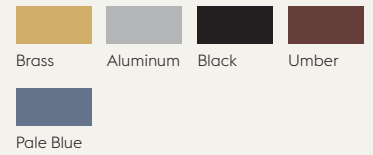

MATERIAL

Solid brass, anodized solid aluminum or stainless steel with PVD vacuum treated surface

FOLDED SHELVES

by Johan van Hengel

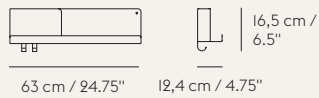
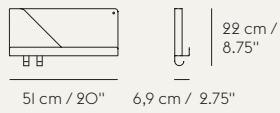

OPTION

All shelves come with 2 black bolts and 2 black hooks

MATERIAL

Acrylic powder coated steel

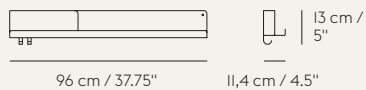

RESTORE BASKET

by Mika Tolvanen

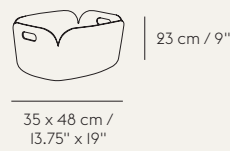

MATERIAL

Polymer felt

RESTORE TRAY

by Mika Tolvanen

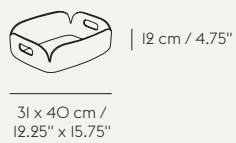

MATERIAL

Polymer felt

RESTORE ROUND BASKET

by Mika Tolvanen

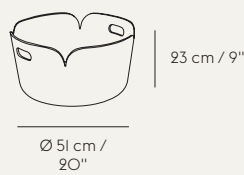

MATERIAL

Polymer felt

FRAMED MIRROR
by Anderssen & Voll

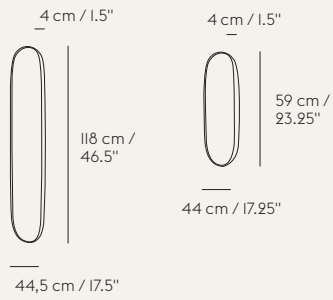

Frame / mirror glass



MATERIAL
Powder coated steel, mirror glass sheet

CORKY CARAFE & GLASSES
by Andreas Engesvik



MATERIAL
Glass, cork

Accessories

PUSH COFFEEMAKER
by Mette Duedahl

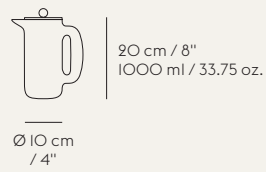

MATERIAL
Jug in stoneware, plastic lid, steel plunger

PLUS GRINDER
by Norway Says

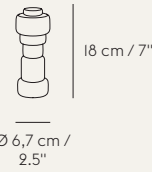

MATERIAL
Maple wood or lacquered beech wood

CRUSHED BOWL
by Julien De Smedt

62



MATERIAL
Handcrafted fine porcelain, white - glazed



GROOVE TRIVET
by Hallgeir Homstvedt

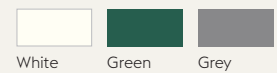
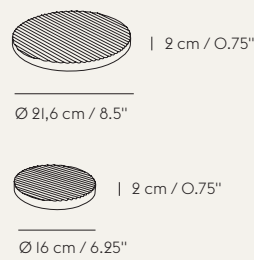

MATERIAL
Solid marble

PLATFORM TRAY
by Sam Hecht & Kim Colin



MATERIAL
Tray in ABS. Insert in laminated oak veneer

COMPILE BOOKEND
by Cecilie Manz

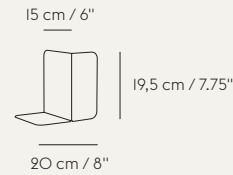

MATERIAL
Powder coated steel

OPEN CANDELABRA
by Jens Fager

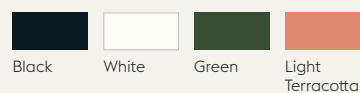
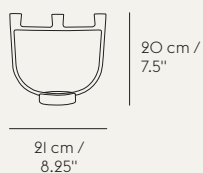

MATERIAL
Powder coated aluminum alloy

FLOAT CANDLESTICK
by Anderssen & Voll

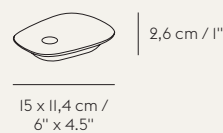

MATERIAL
Cast aluminium

ELEVATED VASE
by Thomas Bentzen

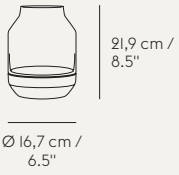

MATERIAL
Mouth blown glass and solid ash wood

MIMIC MIRROR
by Normal Studio

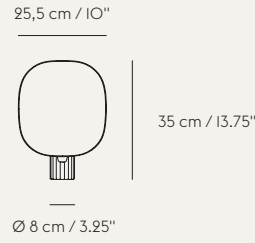

MATERIAL
Base in polyresin plastic, mirror-back in injection molded ABS with soft coating

SILENT VASE
by Andreas Engesvik

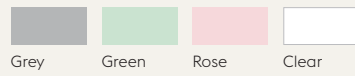

MATERIAL
Handmade and mouth-blown glass

PEBBLE RUG
by Margrethe Odgaard

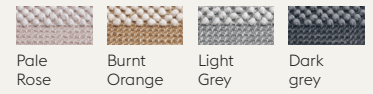
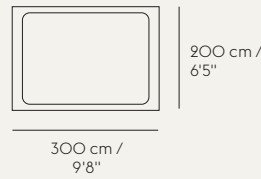

MATERIAL
60% New Zealand wool & 40% Jute.

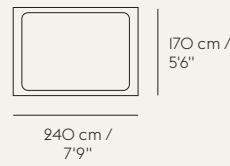

PLY RUG
by Margrethe Odgaard

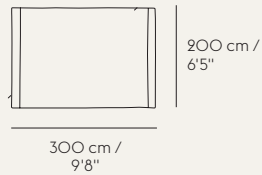

MATERIAL
100% New Zealand wool

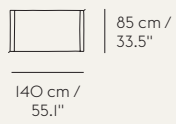
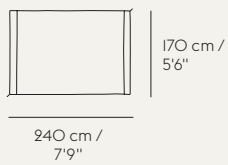

VARJO RUG
by Tina Ratzer

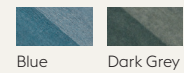
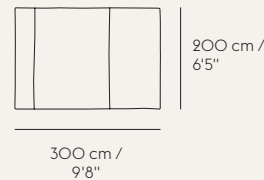

MATERIAL
100% New Zealand wool

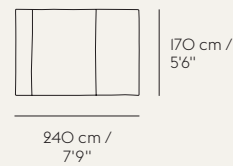

SWAY THROW
by Tina Ratzer

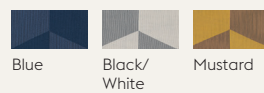
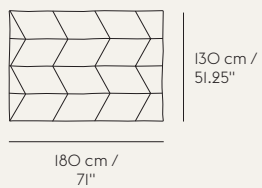

MATERIAL
100% fine merino wool

LOOM THROW
by Simon Key Bertman

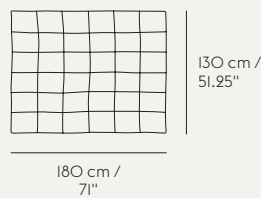

MATERIAL
100% cotton

RIPPLE THROW
by Margrethe Odgaard

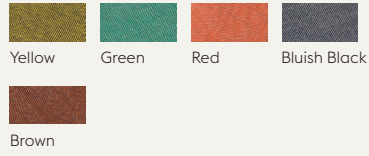
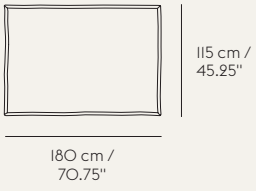

MATERIAL
100% cotton

MINGLE CUSHION
by Thomas Bentzen

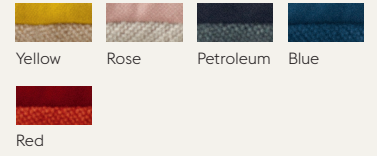
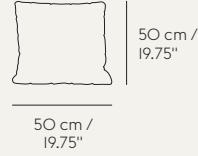

MATERIAL
Textile: Coda / Steelcut from Kvadrat
Filling: Mix of feather and cold-foam granulate mix

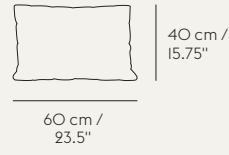

TILE CUSHION
by Anderssen & Voll

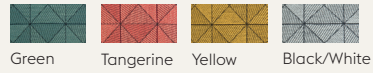
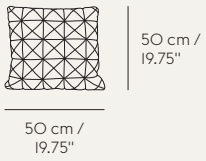

MATERIAL
Fabric: 100% wool textile woven at Gudbrandsdalens Uldvarefabrik in Norway for Muuto.
Filling: Mix of feather and polyester

ACCENT CUSHION
by Margrethe Odgaard

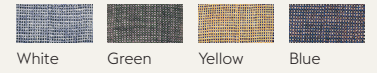
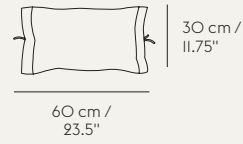

MATERIAL
100% Cotton. Silk print

By the leading
contemporary designers:

Anderssen & Voll
Andreas Bergsaker
Andreas Engesvik
Broberg & Ridderstråle
Cecilie Manz
Claesson Koivisto Rune
David Geckeler
Form Us With Love
Hallgeir Homstvedt
Harri Koskinen
Iskos-Berlin
Jens Fager
Johan van Hengel
Julien De Smedt
Lars Tornøe
Louise Campbell
Margrethe Odgaard
Mattias Ståhlbom
MSDS Studio
Mette Duedahl
Mika Tolvanen
Normal Studio
Norway Says
Sam Hecht & Kim Colin
Simon Key Bertman
Staffan Holm
Søren Rose Studio
TAF Studio
Thomas Bentzen
Thomas Bernstrand
Tina Ratzer
Tom Chung
Whatswhat

MULTI
COM

Styling:
Pernille Vest

Photography:
Petra Bindel / Mikkel Tjellesen / Gils

Printing:
Narayana Press

Subject to
printer's errors